

WHISPER GEN[®]

Personal Power Station

User's Manual

PPS16 Marine and Land Version

Kerosene or Diesel Fuel

12 or 24 Volt Battery Bank Capacity

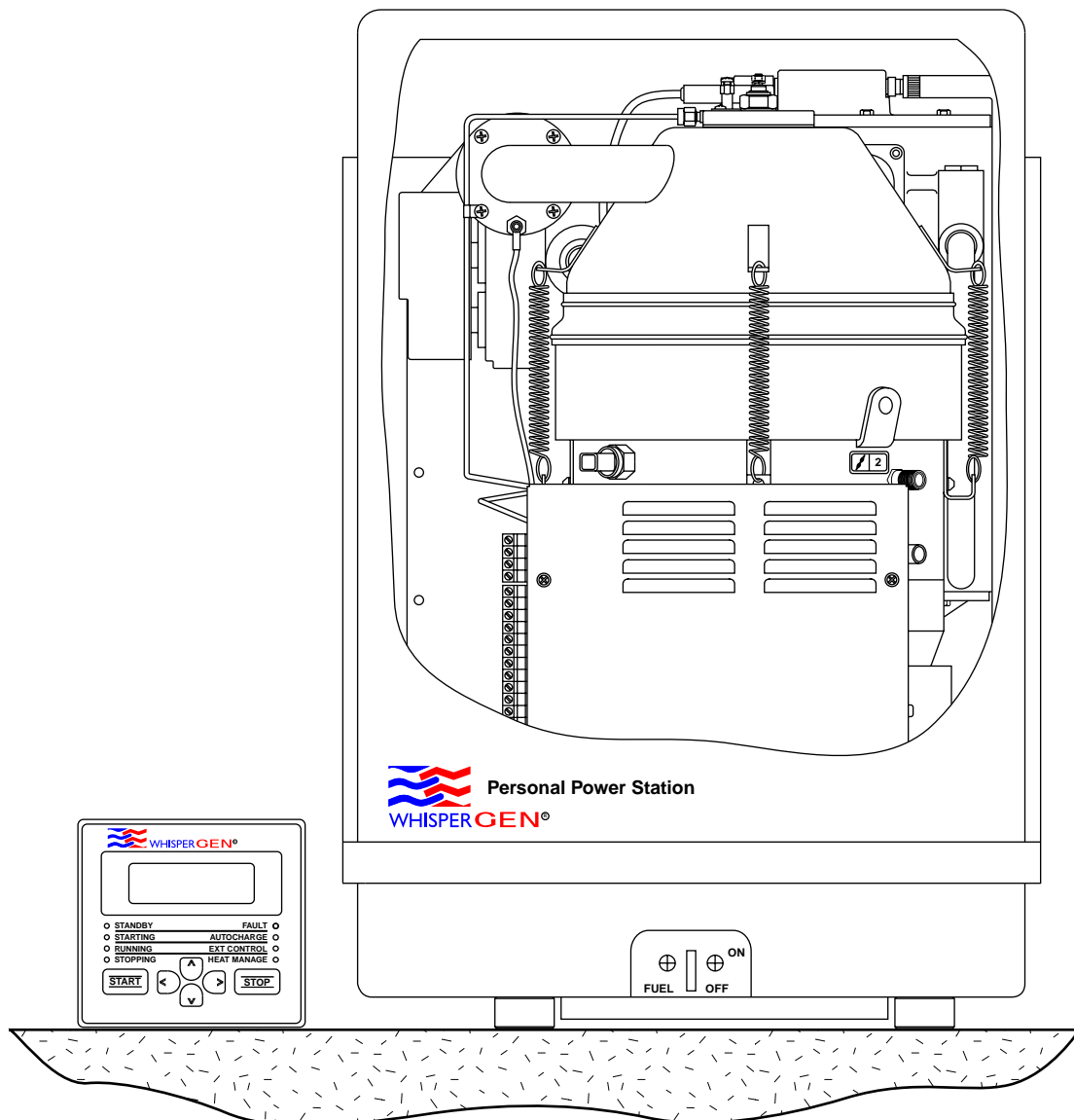

WHISPER TECH LIMITED

Whisper Tech Ltd. reserves the right to revise or change the specifications of its products. This publication describes the state of this product at the time of its publication and may not reflect the product at all times in the future.

Patents granted and pending worldwide.



Whisper Tech , WhisperGen, **WHISPERGEN**[®]
Personal Power Station, and WhisperGen Personal Power Station
are registered trademarks of Whisper Tech Limited.

Title	User Manual PPS16 DC
Part Number	DO-40015-D
C/N Number	464
Application	This manual applies to WhisperGen model numbers PPS16 12 MD, PPS16 24 MD and PPS16 24 LK in the following installations: <ul style="list-style-type: none">• Marine & Land applications.• Diesel & Kerosene fueled burners.• 12V and 24V DC battery systems.

**Copyright © 2002 Whisper Tech Limited.
All rights reserved.**

Printed in New Zealand.

Read this manual from cover to cover before attempting to use the WhisperGen. This manual contains important operating, care and maintenance, trouble shooting, warnings and safety procedures. Follow them! If you don't understand a point in this manual, don't guess. Get help! Contact your authorised WhisperGen representative.

Along with the warnings, instructions and procedures in this manual, the user should also observe such other common sense procedures generally applicable to equipment of this type. If the user does not follow these and other such common sense warnings, instructions and procedures, the WhisperGen may not perform as expected. More seriously, it may cause property damage, personal injury or other losses. The serious risks associated with the WhisperGen are fire, explosion, carbon monoxide and electric shock. Fortunately, these risks are exceedingly remote, provided you know what you are doing and exercise all due care.

Whisper Tech accepts no liability for direct, indirect, incidental, special, or consequential damages resulting from the user's failure (or the failure of the installer or service technician) to follow the warnings, instructions and procedures in this manual or such other common sense procedures generally applicable to equipment of this type. The foregoing limitation extends to damages to person or property caused by the WhisperGen, or damages resulting from the inability to use the WhisperGen, including loss of profits, loss of products, loss of power supply, the cost of arranging an alternative power supply and loss of time, whether incurred by the user, its employees, the installer, a service technician or a third party.

Whisper Tech used all due care in preparing this manual. However, Whisper Tech accepts no liability for errors or omissions.

Whisper Tech reserves the right to change the specifications of its products, or the information in this manual, without necessarily giving its users notice thereof.

The WhisperGen should be installed, commissioned and serviced only by persons approved by an authorised WhisperGen representative to provide such services. Do not attempt to install, commission or service the WhisperGen, yourself, unless you have been so approved. Whisper Tech accepts no liability for personal injury or property damage resulting from faulty installation, commissioning and servicing.

For each installation, operating conditions will vary, sometimes greatly. Such variations may affect the WhisperGen's performance. Whisper Tech has no control over the installation's unique operating environment. Hence, Whisper Tech makes no representations or warranties concerning the performance of the WhisperGen under the actual operating conditions prevailing at the installation. All operating parameters should be validated for your application by a technical expert of your choosing.

Whisper Tech has made every effort to explain operating, care and maintenance, trouble shooting, warnings and safety procedures as clearly and completely as possible. Nonetheless, it is not possible to anticipate, nor address, every conceivable problem that may arise. This problem is compounded by the diversity of operating environments in which the WhisperGen is used. Therefore, Whisper Tech is not able to guarantee that this manual will address every issue or problem that might arise. This manual is intended to provide general guidance. For specific guidance and technical support, contact your authorised WhisperGen representative.

Information in this manual shall not be deemed a warranty, representation or guarantee. For warranty provisions applicable to your WhisperGen, please refer to the warranty provided by the supplier of your WhisperGen.

Unless otherwise noted, a reference to brand names, product names or trademarks constitute the intellectual property of the owner thereof. Subject to your right to use the WhisperGen, Whisper Tech does not convey any right, title or interest in its intellectual property, including, without limitation, its patents, copyrights and know-how.

This manual is for the your personal use only. No part of it may be reproduced or transmitted in any form or by any means without the express written permission of Whisper Tech.

Use of the WhisperGen shall constitute your acceptance of the conditions above.

(Disclaimer Version 1.2 02 02)

Table of Contents

INTRODUCTION

The WhisperGen	1,2
Introduction.....	1
What it does	1
How it works.....	2
Typical Marine Application	3,5
Typical Land Application	4,5
Technical Specifications.....	6,7
Summary of Parts.....	8,9
Control Panel Parts	10
Safety Precautions	11-15

OPERATION

Introduction.....	16
Installing the WhisperGen	16
Quick Reference - Operating Options	16
Information Structure.....	17
Starting the WhisperGen	18,19
Stopping the WhisperGen	20-24
Manual Stopping	20
Emergency Stopping	21
Setting the Maximum Run Time	22-24
Remote Controlling.....	25,26
Managing the Battery Bank	27-29
Stages of Charging.....	27
Auto-Charging the Battery Bank.....	28
Bulk-charging the Battery Bank.....	29
Managing Heat Generation	30,31
Setting the Coolant Temperature	30
Turning On Heat Management.....	31
Clearing Faults and Warnings	32-34
Adjusting the LCD	35,36
Adjusting the Contrast	35
Adjusting the Backlight.....	36
Displaying System Information.....	37-44
Default Display	37
User Menu.....	38
Fault/Warning Menu	38
Extra info Menu	39,40
Installation Menu	40
Displaying Information.....	41,42
Editing Parameter Settings.....	43,44

MAINTENANCE

Introduction	45
Maintenance Schedule.....	45,46
Removing the Enclosure Lid	47
General Checking	48
Checking the Fuel	49
Bleeding the Fuel Line	50-52
Cleaning the Fuel Pump Filter.....	53-54
Checking the Coolant.....	55
Bleeding the Coolant Circuit.....	56-59
Checking Battery Bank Connections.....	60,61
Replacing the Glow Plug.....	62,63
Replacing Fuses	64-66
Replacing the FID	67-69
Replacing the Oxygen Sensor	70,71
Replacing the Evaporator.....	72-74
Flushing the Exhaust Heat Exchanger.....	75-77

TROUBLE SHOOTING

Correcting Faults.....	78-82
Correcting Warnings	82,83
Resetting the WhisperGen	84,85

SERVICE DETAILS	86-89
------------------------------	-------

EC CONFORMITY	90,91
----------------------------	-------

INDEX	92,93
--------------------	-------

The WhisperGen

Introduction

Congratulations on purchasing a WhisperGen PPS16.

This manual is designed to allow you to quickly learn how to safely operate your WhisperGen. Please keep this manual for future reference and read it before operating or maintaining your WhisperGen.



In this manual, warnings against hazards are marked with the symbol shown on the left. Heed all warnings at all times.

For information regarding the standard kit items supplied with each WhisperGen, and if you have any questions or suggestions feel free to contact your authorised WhisperGen agent.

In some countries, it is a requirement that this manual be permanently placed alongside the WhisperGen and maintained in a readable condition. Check with your local authority regarding this requirement.

What it Does

The WhisperGen PPS16 is a Personal Power Station that generates heat and electrical energy simultaneously.

The WhisperGen is capable of charging and managing a lead-acid battery bank to provide a DC electrical power supply.

It also provides heat energy in the form of hot coolant for space heating and domestic hot water generation.

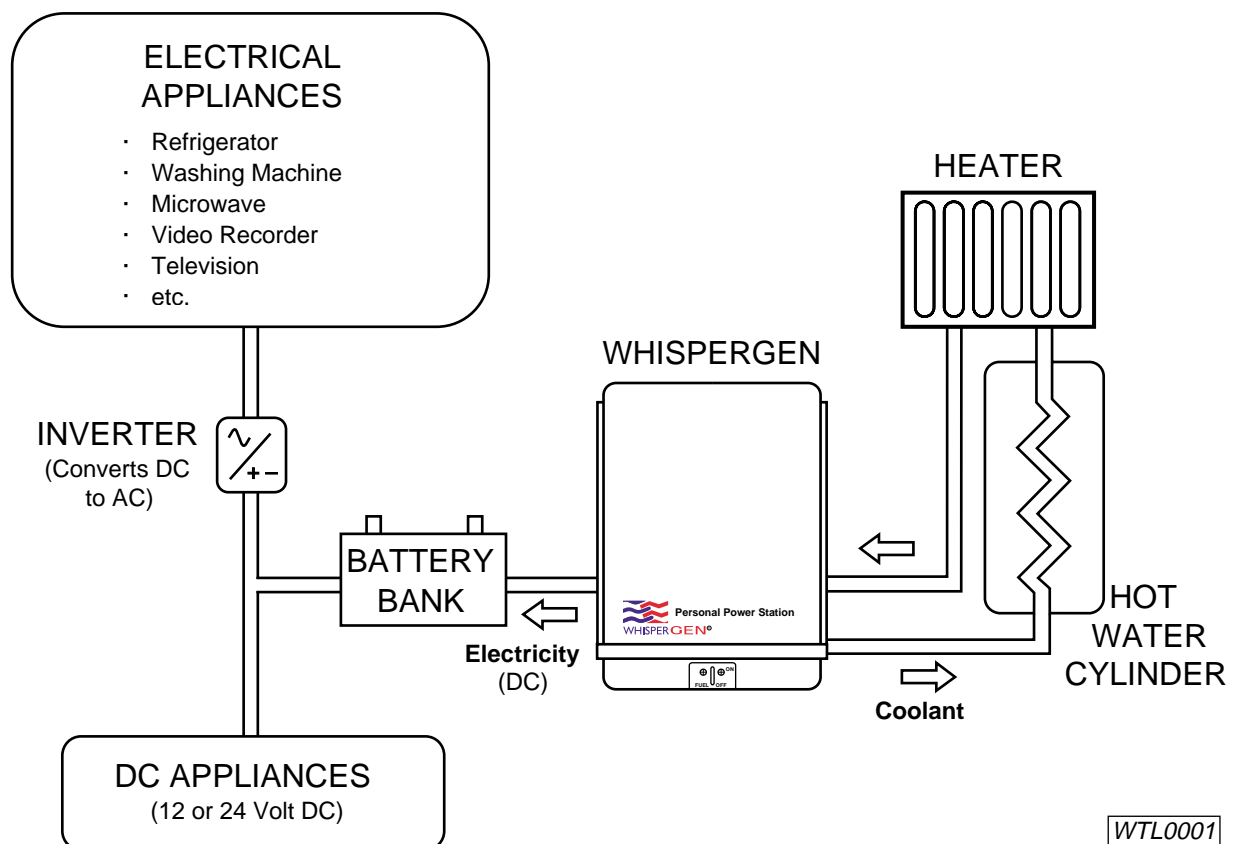

Note: Not all elements of the actual system are shown in this schematic.

How It Works

The WhisperGen PPS16 is based on a four-cylinder Stirling-cycle (external combustion) engine that repeatedly heats and cools a mass of pressurised nitrogen gas. Each time the gas is heated and cooled, the changing gas pressure causes the pistons to move up and down. This mechanical motion, via a special mechanism called the “wobble yoke”, rotates an alternator to generate DC electricity which can be used to charge a lead-acid battery bank.

The nitrogen gas is heated by a continuous-combustion burner, and cooled by coolant circulating through engine cavities. Heat transferred to the coolant can be used to heat domestic water cylinders and for space heating.

The burner consumes air and fuel. The flow rate of air and fuel into the burner is optimised by a microcomputer. This maximises combustion efficiency and minimises exhaust emissions.

The microcomputer automatically controls all WhisperGen functions and displays real-time information about the system on a control panel from which the user can also alter operating options.

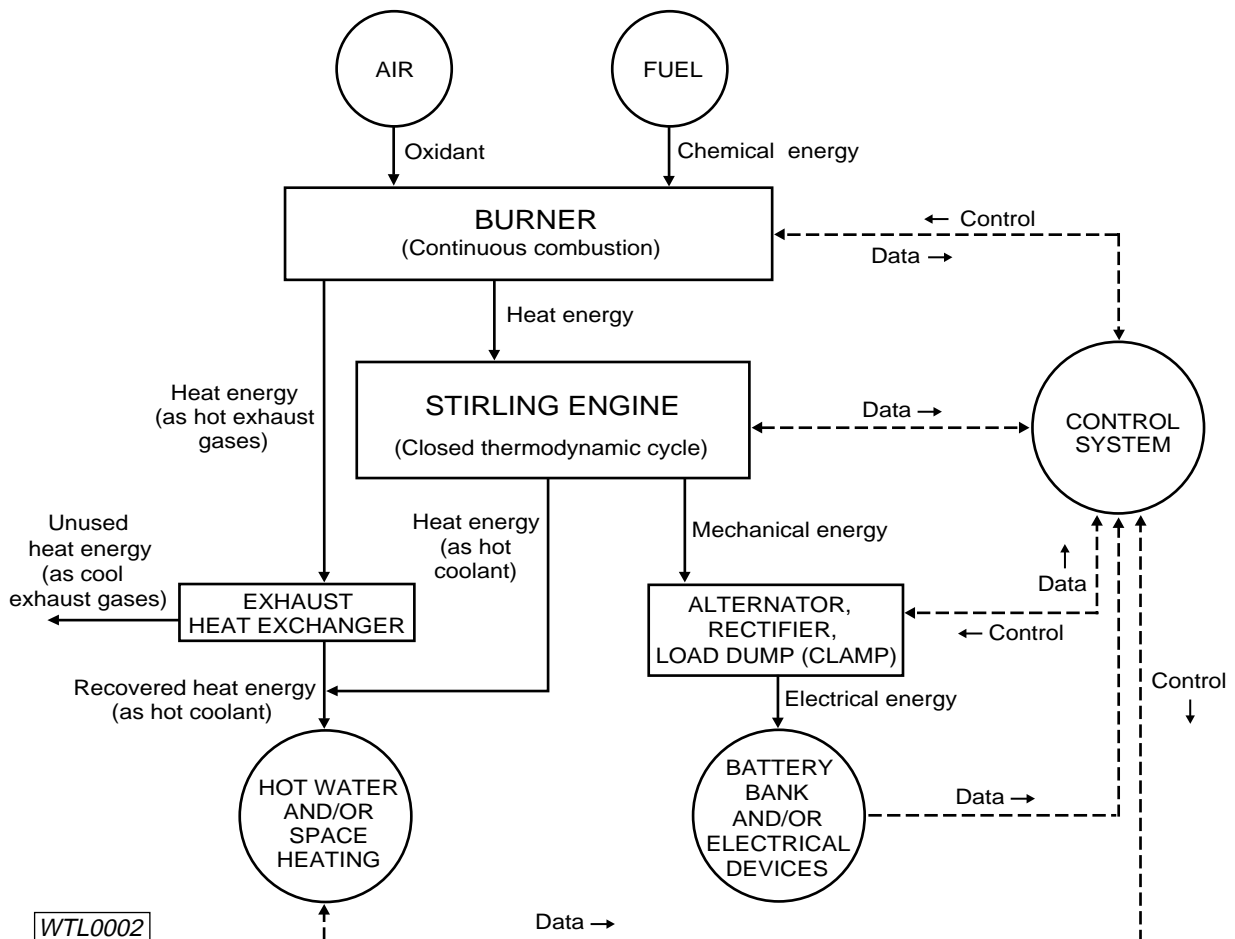

Typical Marine Application

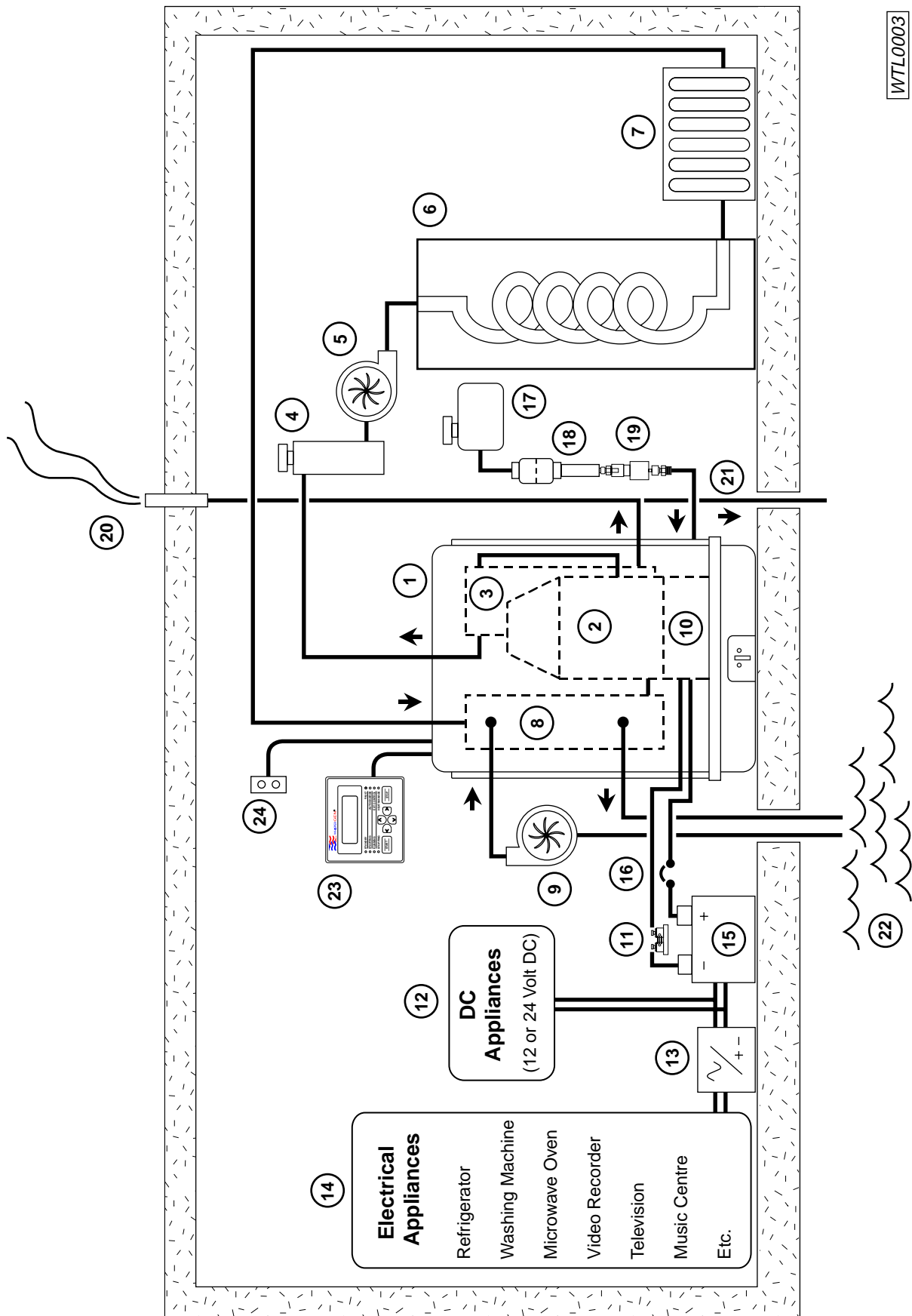

WTL0003

Typical Land Application

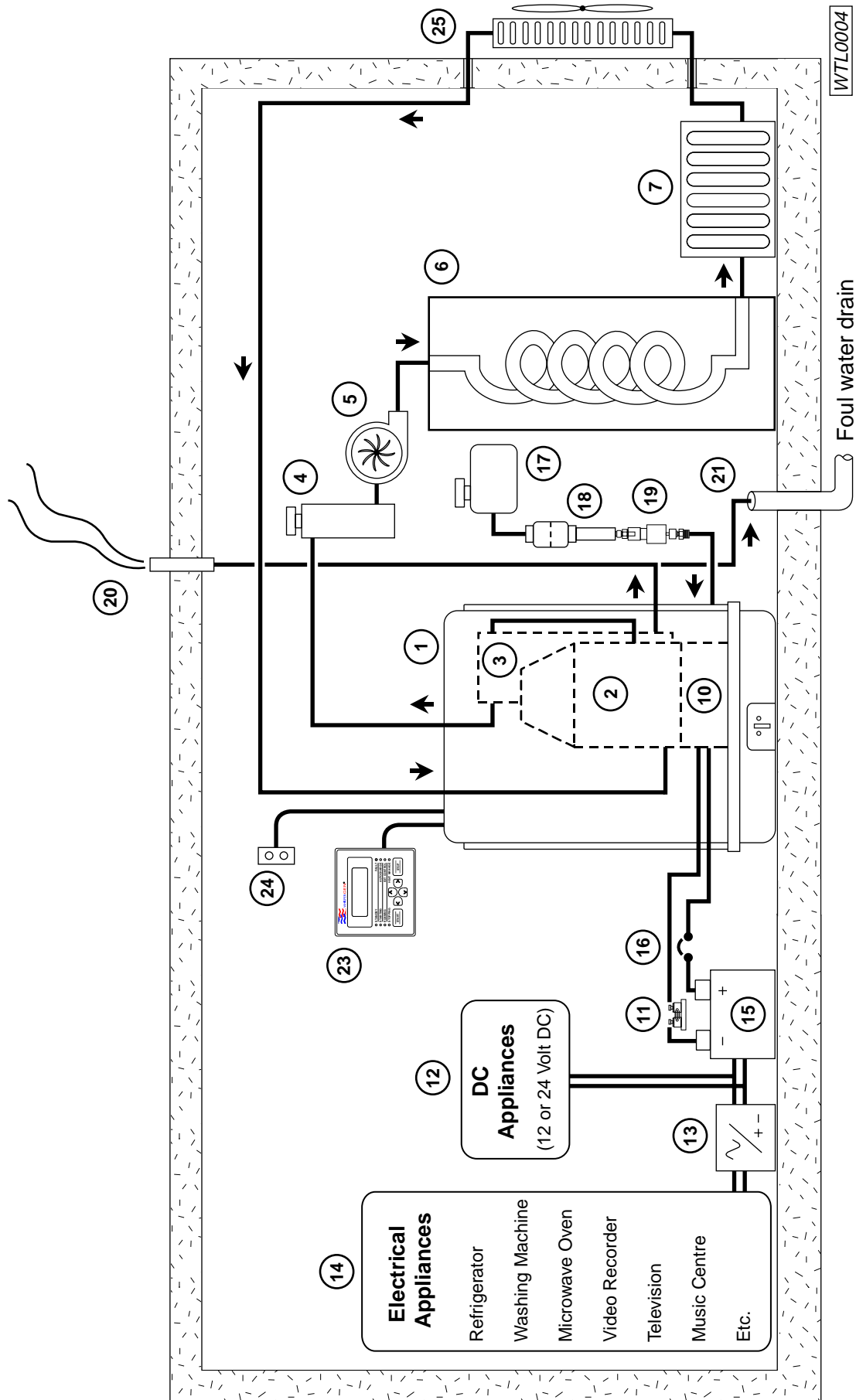

No	Description
1	WhisperGen PPS16.
2	Engine Block.
3	Exhaust heat exchanger.
4	Coolant header tank.
5	Coolant pump.
6	Hot water cylinder (optional).
7	Space heater (optional).
8	Marine heat exchanger.
9	Seawater pump.
10	Electronics enclosure.
11	Current shunt.
12	DC appliances (12/24 Volt).
13	Inverter (DC to 230/110 Volt AC).
14	Electrical appliances (230/110 Volt AC).
15	Battery bank (12/24 Volt).
16	Circuit breaker.
17	Fuel tank.
18	Fuel filter.
19	Fuel pump.
20	Exhaust gases vented into atmosphere.
21	Condensate drain.
22	Seawater.
23	Control panel.
24	Remote start/stop switch (optional).
25	External heat dump radiator (optional).

Technical Specifications

Specifications subject to change without notice

Feature	Specification	Remark
Prime mover	4-cylinder Stirling-cycle engine pressurised to 28 bar with nitrogen.	Closed thermodynamic cycle.
Power output	Co-generation of heat and electricity.	
Heat	5kW useable heat.	Heat output depends on operating conditions.
Electrical	750W electrical.	Gross output depends on operating conditions.
Duty cycle	1 to 24 hours per day.	
Fuel **		
Type	Kerosene: BS2869: 2000 Class C1 or C2	Minimum flash point, closed, 43°C for C1, 38° C for C2.
Type	Diesel: EN590; BS2869: 2000 Class A2, D.	Minimum flash point, closed, 56°C.
Consumption	Less than 1 litre per hour.	At nominal power output.
Control		
Manual	Manual start/stop from control panel.	
External	Optional remote starting via external switch.	Timer, thermostat, or on/off switch may be used.
Auto-charge	Optional automatic battery bank charging.	Starts and stops at preset discharge levels.
Heat management	Optional automatic heat generation to maintain coolant temperature.	Coolant temperature is user-selectable.
External heater	Optional control of an external heater to boost and maintain coolant temperature.	Coolant temperature is user-selectable.
Electrical **		
Nominal voltage	12V or 24V DC.	
Battery bank capacity	12V: 200Ah minimum recommended. 24V: 100Ah minimum recommended.	Battery bank not included in standard kit.
Battery bank charging	3-stage charging on each run: bulk, absorption, and float.	Battery bank voltage, current, and Amp-hours monitored and displayed on control panel.
** Machine type is set at the factory		

Feature	Specification	Remark
Cooling system		
Cooling method	Primary Cooling: Automotive type glycol-based corrosion-inhibited antifreeze.	Removes heat from engine.
	Secondary Cooling: Water-cooling (marine applications). External Radiator (land applications).	Heat is transferred to hot water cylinder(s) and space heater(s).
Heat exchangers	Internal exhaust and marine heat exchangers.	Requires external coolant pump and seawater pump.
Exhaust temperature	80°C nominal, 95°C maximum.	Cooling system extracts heat from exhaust.
Connections		
		All connections provided on the rear panel of the enclosure.
Fuel	Rp 1/8 (ISO 7-1).	BSPP 1/8
Heat exchangers	Rp 3/4 (ISO 7-1).	BSPP 3/4
Exhaust	Rp 1 1/4 (ISO 7-1).	Exhaust must be vented outside occupied areas.
Exhaust flushing	G 3/4 (ISO 228-1).	Face sealing fitting required.
Condensate draining	12.7mm O.D. plain tube.	
Battery bank	35mm ² screw terminals.	
External switch	0.5 to 2.5mm ² screw terminals.	
PC	RJ 45.	Via RS485-to-RS232 converter.
Physical		
Dimensions	450mm (W) x 500mm (D) x 650mm (H).	
Dry weight	90kg.	
Environmental		
Temperature/humidity	-10°C to 40°C. 99% RH, non-condensing.	With suitable fuel and coolants.
Compliance		
Machinery directive	98/37/EC.	
Noise	ISO 8528-10.	50dBA at 7m.
EMC directive	89/336/EC, 92/31/EC and 98/13/EC.	
EMC	EN50081-1.	Radiated and conducted emissions. RF field, ESD, and fast transient immunity.
	EN50082-1.	

Summary of Parts

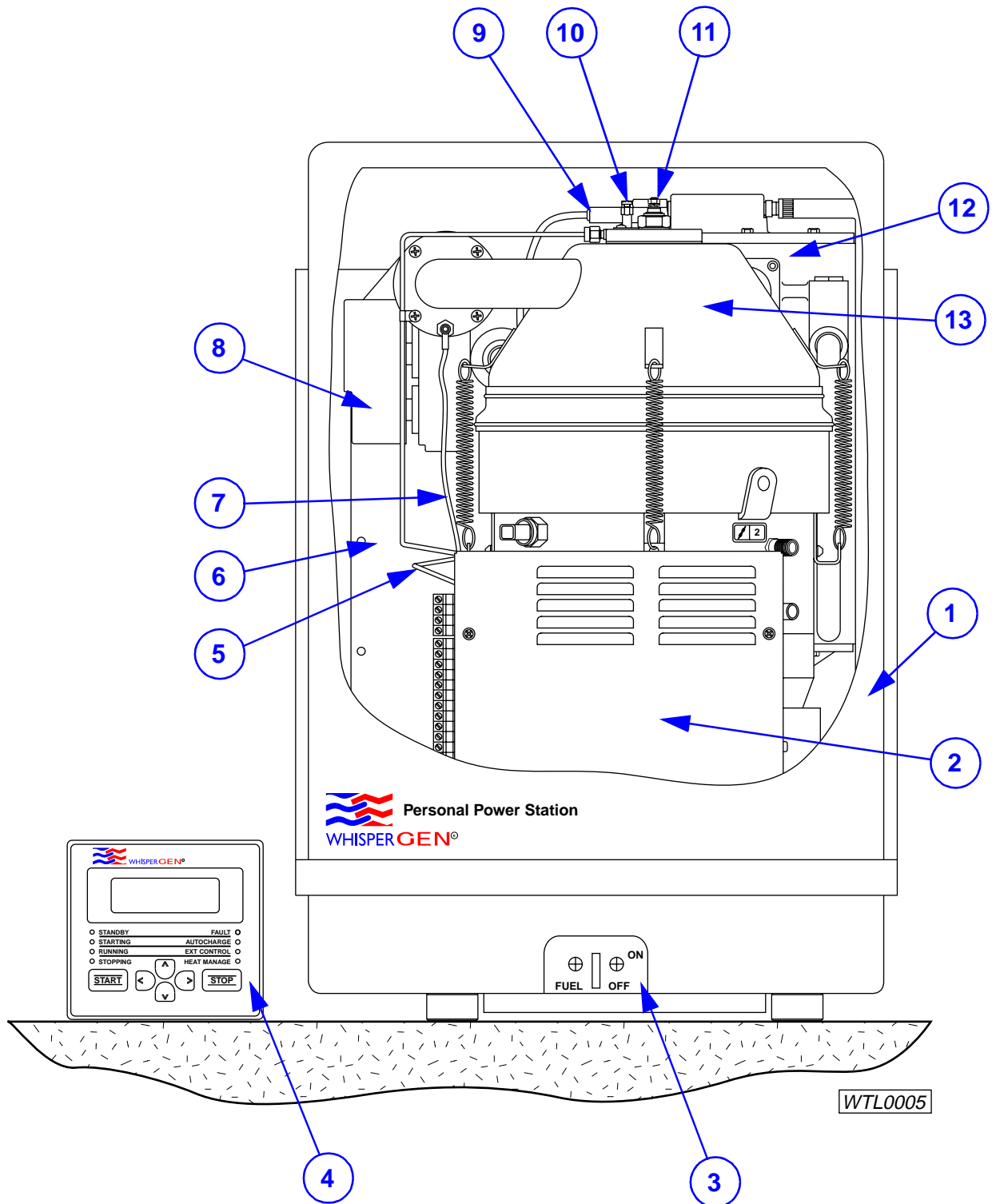

No	Name	Function
1	Enclosure	The fibreglass-reinforced cover that protects the internal parts of the WhisperGen.
2	Electronics Enclosure	The electronics, including a microcomputer, that controls all WhisperGen functions and regulates power supply to and from the WhisperGen and battery bank.
3	Fuel Valve	A manually operated valve that isolates the WhisperGen from its fuel supply, stopping combustion and shutting down the engine.
4	Control Panel	The remote panel for viewing information about the WhisperGen system and controlling operating parameters.
5	Fuel Line	The tube through which fuel is supplied to the burner.
6	Marine Heat Exchanger (Marine version only)	A device that transfers excess heat energy from the coolant to seawater.
7	Earthing Strap	The earthing cable for the glow plug.
8	Air Blower	The fan that supplies air to the burner.
9	Oxygen Sensor	A sensor that feeds back to the microcomputer the air/fuel ratio.
10	FID	A flame-ionisation detector that detects the presence of flames in the burner.
11	Glow Plug	A device to preheat the burner and ignite incoming fuel.
12	Exhaust Heat Exchanger	A device that extracts heat energy from the exhaust gases.
13	Burner	A continuous-combustion device that supplies heat to the engine.

Control Panel Parts

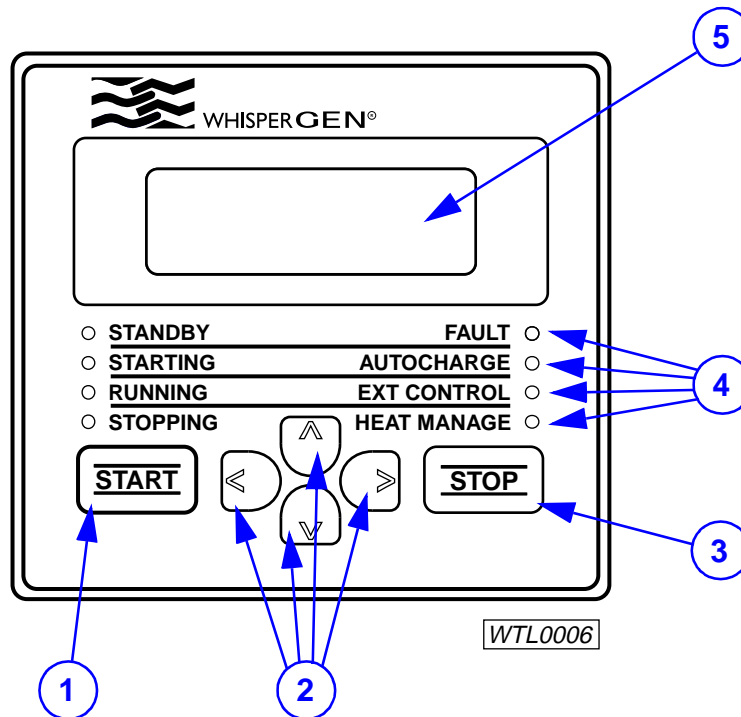

No	Name	Function
1	START Key	The key that: (a) Starts up the WhisperGen; (b) Begins battery bank bulk-charging; and (c) Clears faults.
2	SELECT Keys	The arrow keys that provide access to system menus for; (a) Information display; and (b) Editing system parameters.
3	STOP Key	The key that shuts down the WhisperGen.
4	Indicators	The lights that indicate the status of the WhisperGen system. STANDBY: the WhisperGen is ready to start. STARTING: the WhisperGen is starting. RUNNING: the WhisperGen is operating. STOPPING: the WhisperGen is stopping. FAULT: a fault or warning is present. AUTOCHARGE: the battery bank auto-charging function is turned on. EXT CONTROL: external control of the WhisperGen is enabled. HEAT MANAGE: the heat management function is turned on.
5	LCD Panel	A liquid-crystal display that shows system information such as charging current, battery bank voltage, power output, etc.

Safety Precautions



Please read and understand this section ENTIRELY before operating or maintaining the WhisperGen. Not heeding the warnings or recommendations could damage the WhisperGen, cause personal injury, and/or void the warranty.

In some countries, this manual must be permanently placed alongside the WhisperGen and maintained in a readable condition. Consult your local authority for information.

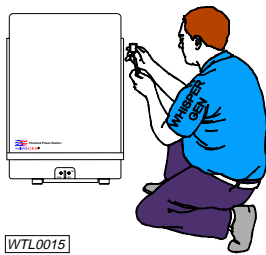
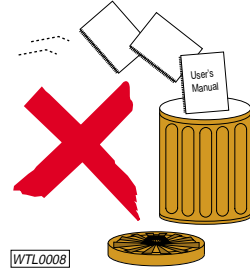

The WhisperGen is a pressurised device and must be installed and serviced by an authorised WhisperGen service agent. Incorrect installation or servicing can damage the WhisperGen and property, cause personal injury, and/or void the warranty.

Always heed warning signs on the WhisperGen. The engine contains high-pressure nitrogen and some internal surfaces are hot.

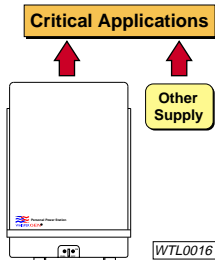

Never use the WhisperGen as the sole source of electrical power for critical applications.

The WhisperGen should be pressurised by an authorised service agent only. Do not do it yourself and do not adjust the pressure-relief valve.

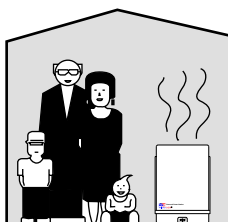
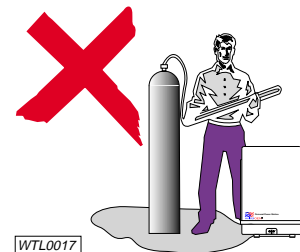

Exhaust gases from the WhisperGen should at all times be vented outside enclosed areas. Exhaust piping in enclosed areas must be properly sealed.

Never remove the burner earthing strap as this will cause the fuel line to act as the earthing path for the glow plug. The fuel could heat up, causing a malfunction or a fire.

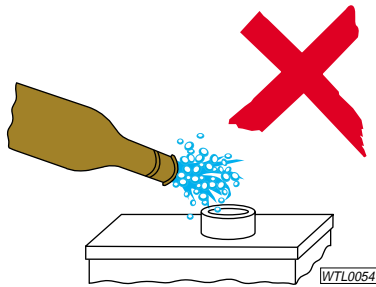
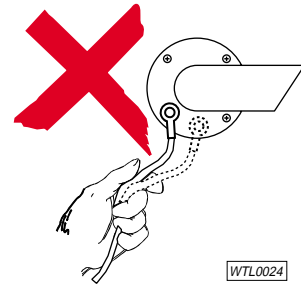

Do not use fuels other than the specified class of fuel as this may damage the WhisperGen and/or cause a fire.

Air bubbles present in the fuel line can cause the WhisperGen to malfunction – bleed the fuel line after filling a completely empty fuel tank.

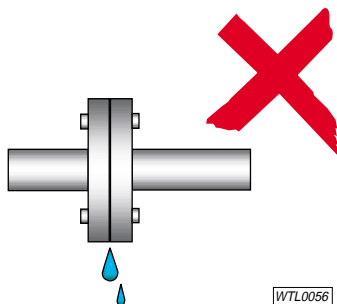
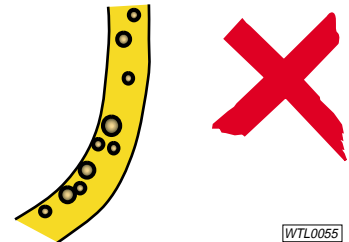

The cooling system is vital to the performance of the WhisperGen. If there are leakages in the cooling circuit, or the water is not flowing inform an authorised WhisperGen agent immediately.

Use only the recommended coolant mixture. Using an incorrect type of coolant fluid can cause serious corrosion in the WhisperGen.

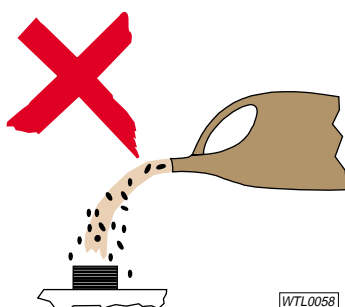

Ensure that fuel and coolant used on the WhisperGen are clean and free of particulate contaminants. Foreign particles can obstruct fuel/coolant passages, resulting in a malfunction or damage to the WhisperGen.

Do not operate the WhisperGen in a potentially explosive environment.

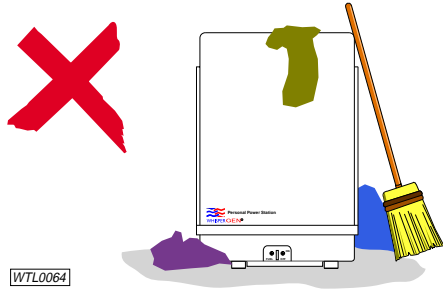
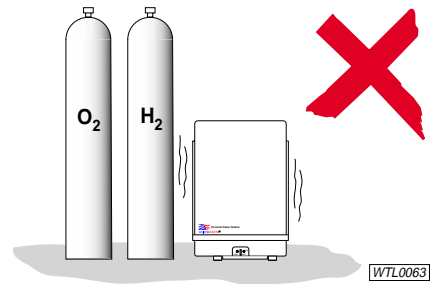

Do not store rags or other items inside or beside the WhisperGen as the air circulation through the WhisperGen may be disrupted.

Do not drill holes in the enclosure. Air circulation through the WhisperGen may be disrupted.

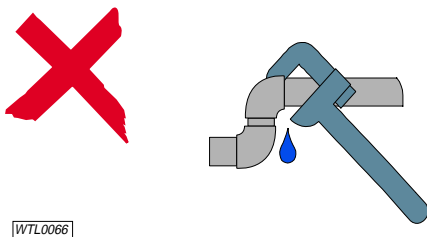
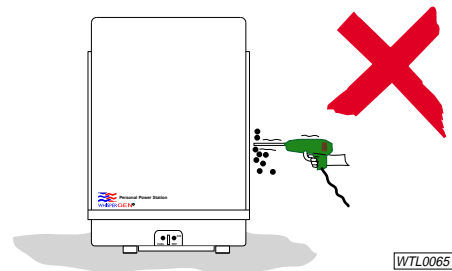

Do not modify the piping for the fuel, exhaust, and cooling systems of the WhisperGen without first consulting an authorised WhisperGen agent.

Isolate the WhisperGen from the battery bank before making or breaking other connections on the battery bank.

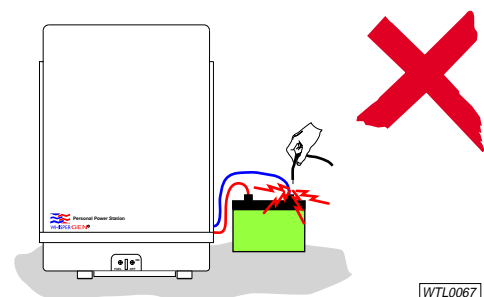

During normal operation of the WhisperGen, the enclosure lid and electronics enclosure lid must be fitted.

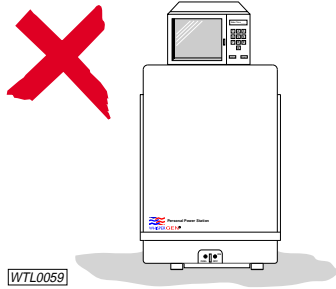
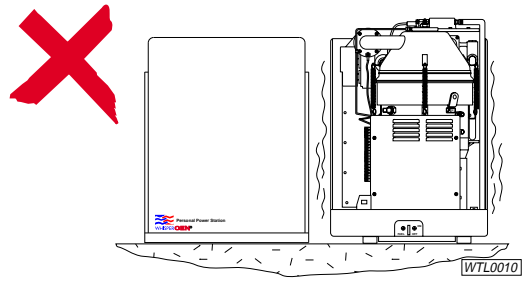

Do not sit anything on the WhisperGen or press down hard on the top.

Do not expose the WhisperGen to large physical impacts.

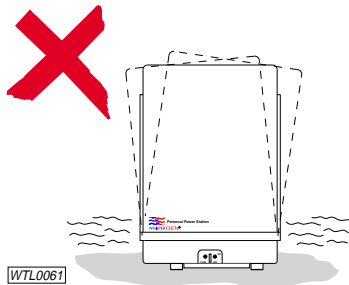
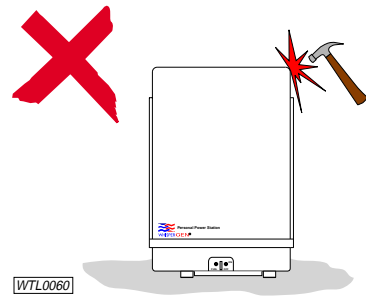

Do not expose the WhisperGen to excessive vibration.

Do not expose the WhisperGen to extreme temperatures. The ambient temperature should not exceed 40°C or fall below -10°C.

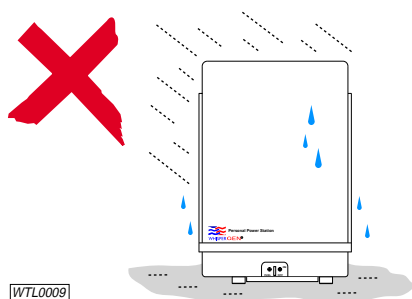
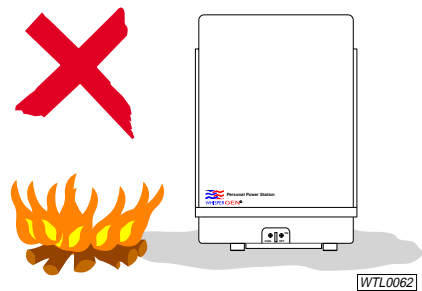

Do not install, operate, or store the WhisperGen in a wet or poorly ventilated place.

- 1. Check x
 - 2. Check y
 - 3. Clean p
 - 4. Clean q
- WTL0069

Ensure that maintenance procedures and schedules as recommended in this manual are adhered to at all times.

Perform maintenance procedures mentioned in this manual only. If in doubt, call your authorised WhisperGen service agent.

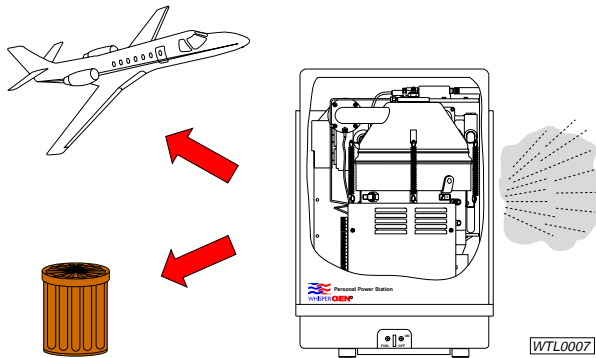
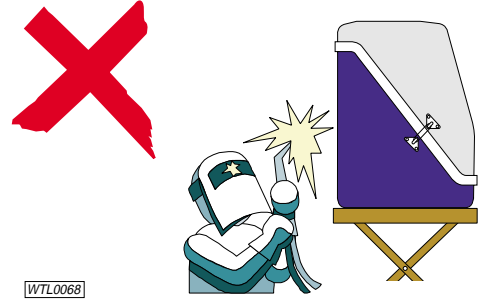

Before the WhisperGen is transported by air or disposed, fluids in it must be drained and the engine must be depressurised. Consult your authorised WhisperGen service agent for advice.

In some countries, it is a requirement that a maintained fire extinguisher be permanently located alongside an installed WhisperGen. Consult your local authority for information.

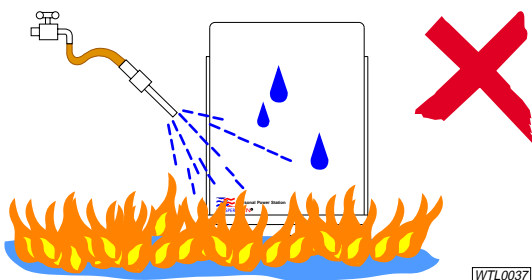
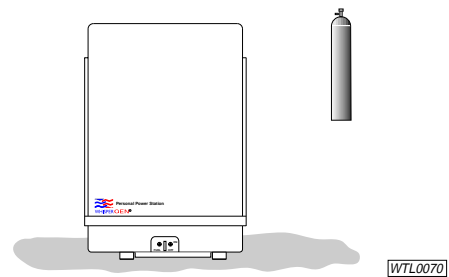

In case of fire, use a carbon dioxide or dry powder extinguisher – do not use water.

Operation

Introduction

This section outlines the procedure for operating your WhisperGen. It will show you how to:

- Start and stop the WhisperGen;
- Charge the battery bank;
- Manage heat generation;
- Clear faults and warnings;
- Adjust the contrast of the LCD; and
- Display and edit system parameters of the WhisperGen.



You should read and understand all safety precautions before operating your WhisperGen.

Installing the WhisperGen

To install the WhisperGen, contact your authorised WhisperGen service agent. The contact details for your authorised WhisperGen service agent appear at the back of this manual.



The WhisperGen must be installed by an authorised WhisperGen service agent. If you install the WhisperGen yourself, the warranty will be void. Incorrect installation may damage the WhisperGen and property, and/or cause personal injury.

Quick Reference - Operating Options

Depending on the options selected, the WhisperGen may stop running before or after the battery bank is charged, as shown in the table below.

WhisperGen starting method	Heat Manage ON		Heat Manage OFF	
	Max Run Hours < 25	Max Run Hours = 25	Max Run Hours < 25	Max Run Hours = 25
Manual start	Stops when Max Run Hours value is reached, even if the battery bank is not yet fully charged.	Continues running until stopped by the user.	Stops when the battery bank is charged or when Max Run Hours value is reached, whichever comes first.	Continues running until the battery bank is charged, then stops.
Remote switch start with Ext Cont Mode set to 1		Continues running until stopped by the user or remote switch.		
Remote switch start with Ext Cont Mode set to 2*				
Auto-charge start	Stops when the battery bank is charged, regardless of Max Run Hours and Heat Manage settings.			

In all cases, the WhisperGen can be stopped at any time by pressing **STOP** on the control panel.

* In this mode, the WhisperGen will run for at least one hour.

Information Structure

The information displayed on the control panel is structured as shown below. For an explanation on how to navigate within this information panel structure, individual parameter meanings and edit settings refer the section entitled Displaying System Information.

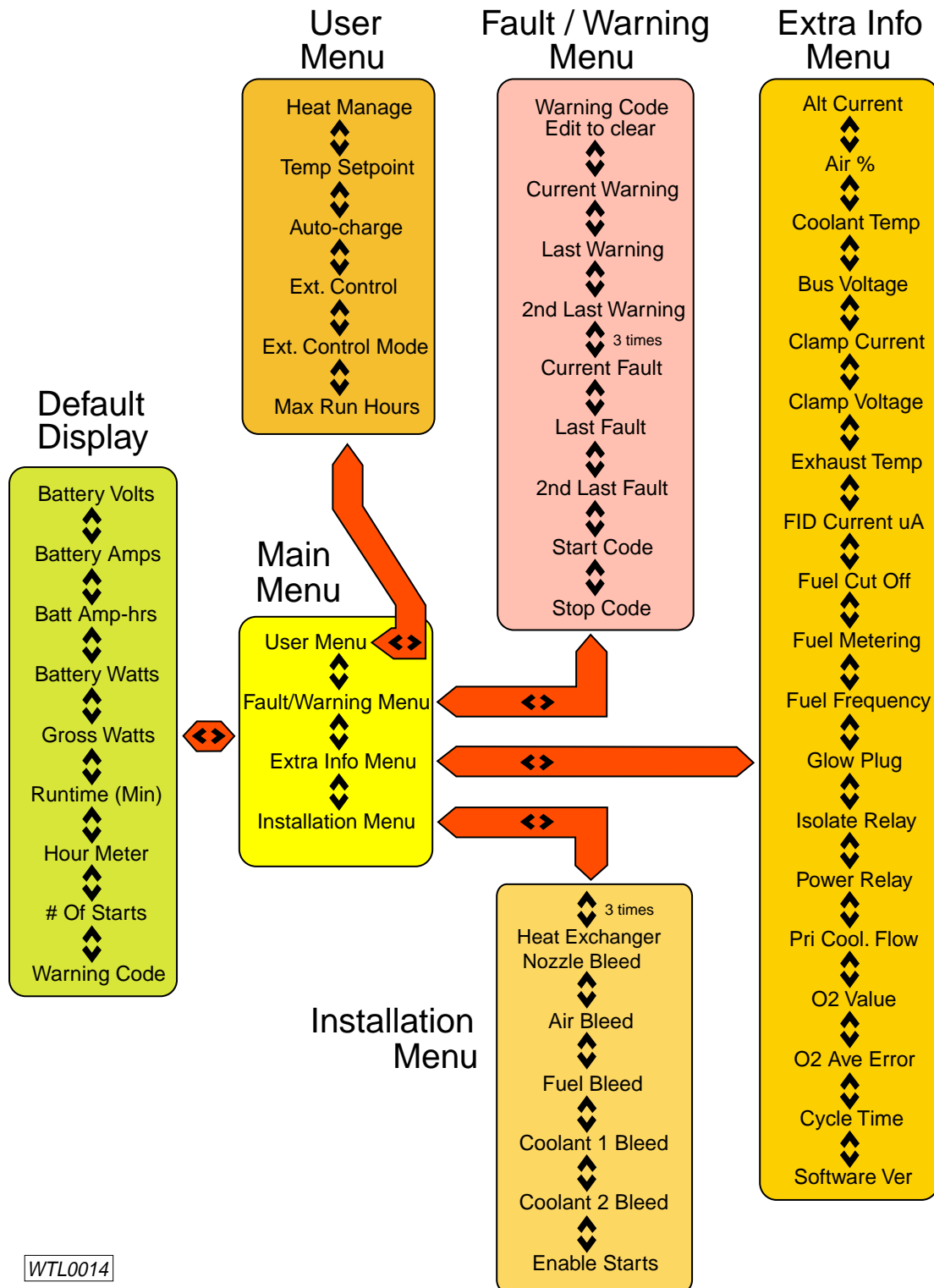

WTL0014

Starting the WhisperGen

To manually start the WhisperGen:

1. Check that the **STANDBY** indicator on the control panel is lit. If the fault indicator is constantly lit, you will need to clear the fault – see section entitled Clearing Faults and Warnings. If nothing is displayed on the control panel, check that the WhisperGen is connected to the battery bank and that the 3A fuse (F2 position as marked on PCB) is not blown.

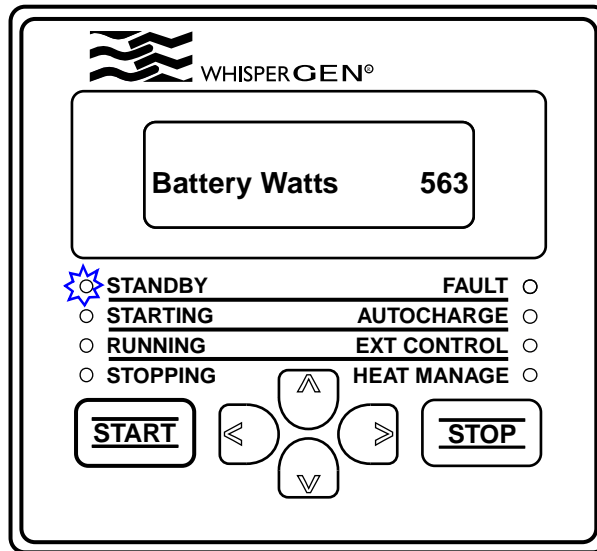

WTL0006

2. Turn on the fuel valve.

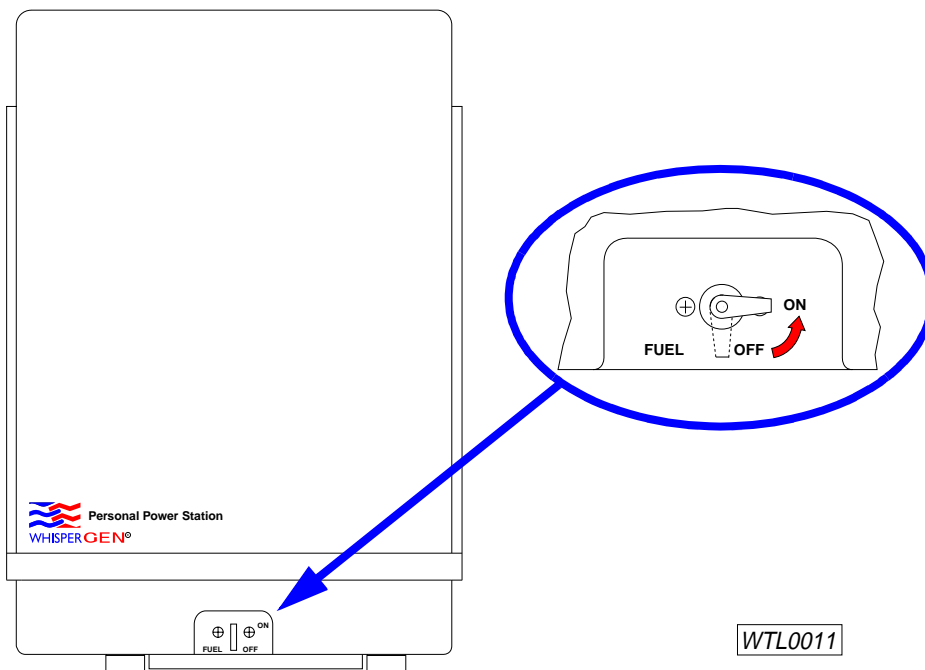

WTL0011

3. Hold down **START** on the control panel until all indicators flash and a beep is heard. The **STARTING** indicator will light up and “Manual start” will be displayed on the control panel. As an anti-tamper feature, short presses of the **START** key are ignored.

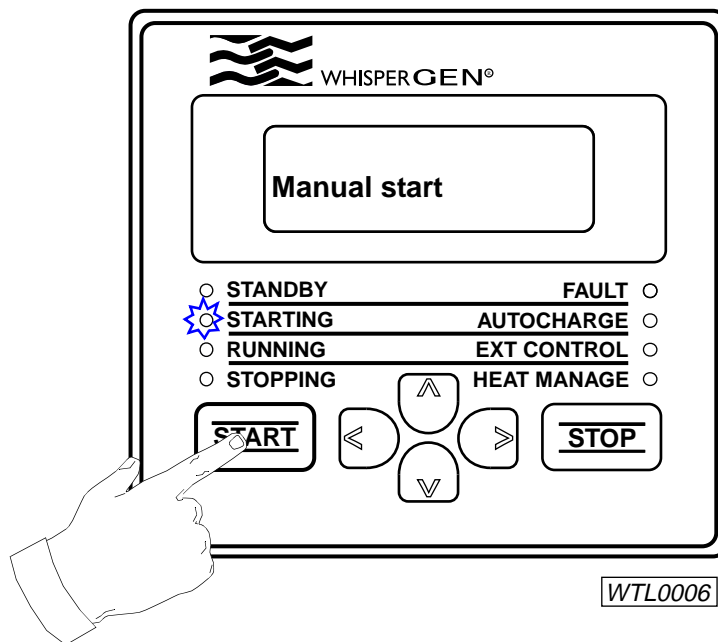

In the starting mode, as indicated by a lit **STARTING** indicator, the WhisperGen goes through a starting-up sequence over a few minutes during which the engine is heated to a working temperature. The WhisperGen is operating normally when the **RUNNING** indicator lights up and the control panel displays “Bulk Charge”. This may take up to 10 minutes. If a fault occurs, the WhisperGen may automatically attempt to restart. By default, the WhisperGen will attempt to restart once. If you wish to change this setting, contact your authorised WhisperGen agent.

Every time the WhisperGen is operated, the battery bank is charged. Once the battery bank is fully charged**, the WhisperGen automatically stops and returns to the standby mode (as indicated by a lit **STANDBY** indicator) if the default settings are used. (i.e. Auto charge mode)

If the WhisperGen is in Heat Manage mode, the WhisperGen will continue to run for as long as there is a heat demand.

If you press **START** while the WhisperGen is in the process of stopping, it will ignore the key press and continue stopping. The WhisperGen must be in the standby mode before it can be started. The WhisperGen must also be allowed to cool down before it can be restarted.

The WhisperGen can also be started by remote switch, refer to section entitled Remote Controlling for more details.

*** If the WhisperGen is started manually or from a remote switch, and the **Max Run Hours** setting is less than **25**, the WhisperGen will automatically stop when the **Max Run Hours** set value is reached, even if the battery bank is not yet fully charged.*

Stopping the WhisperGen

Manual Stopping

The default setting of the **Heat Manage** option is **OFF**. Unless it is turned **ON**, the WhisperGen automatically stops once the battery bank is fully charged - you do not need to manually stop the unit.

Should you wish to manually stop the WhisperGen refer to the following:

1. Hold down **STOP** on the control on the control panel until a beep is heard. The **STOPPING** indicator will light up and “Running down” will be displayed on the control panel. As an anti-tamper feature, short presses of the **STOP** key are ignored.

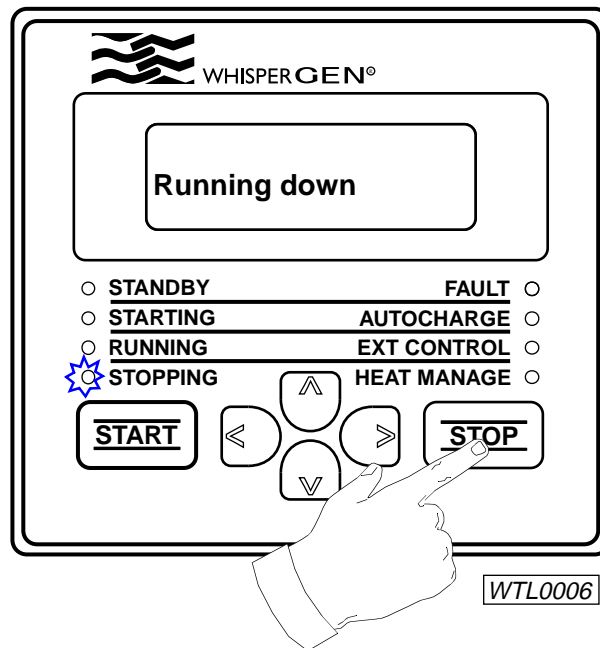

In the stopping mode, as indicated by a lit **STOPPING** indicator, the WhisperGen goes through a shutdown sequence lasting two to five minutes during which the engine is cooled down.

When the WhisperGen has fully stopped, the **STANDBY** indicator lights up and the control panel displays “WhisperGen”. The WhisperGen must be in the standby mode before it can be started again.

If a remote switch has been installed to control the WhisperGen, you can also stop the WhisperGen with the remote switch, refer to section entitled Remote Controlling for more details.

If you stop the WhisperGen manually or from a remote switch when it is auto-charging the battery bank, the WhisperGen will immediately start again if the battery bank charge level is still below the set level. To prevent the WhisperGen from restarting, turn the **Auto-charge** option **OFF**, refer to section entitled Managing the Battery Bank - Auto charging.

Emergency Stopping

To stop the WhisperGen in an emergency:

1. Turn off the fuel valve in front of the WhisperGen.

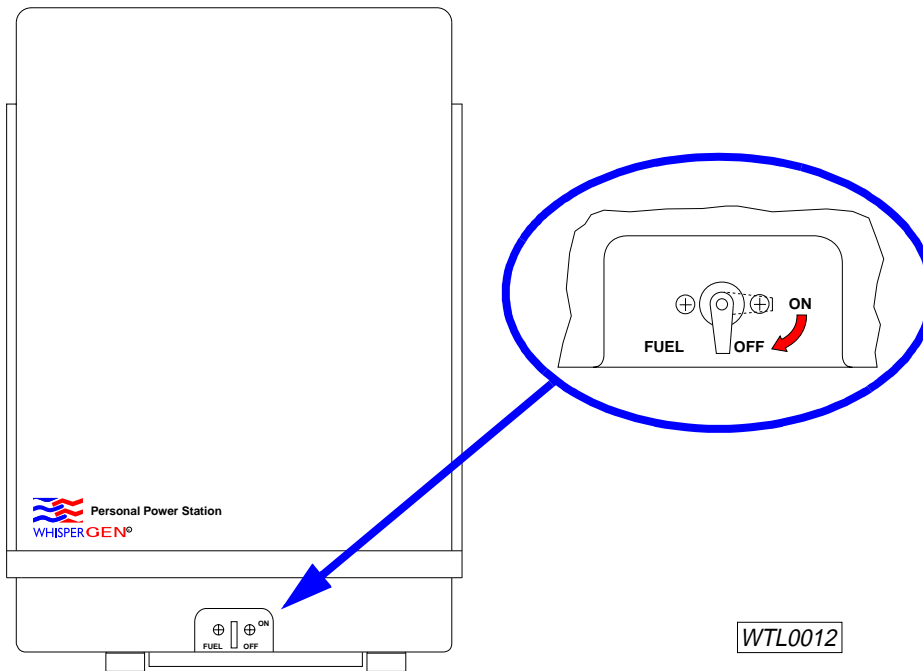

The flame in the WhisperGen burner will be extinguished within a few seconds. The fuel cut-off will be registered as a fault and the WhisperGen will stop. The fault will need to be cleared (see section entitled Clearing Faults and Warnings) before the WhisperGen can be started again.

The WhisperGen will attempt to re-start (if auto restart is enabled). If the fuel valve remains off, the attempt will fail. It is recommended that once the fuel valve has been turned off and the stop button on the control panel activated, this will cancel all auto-restarts.



Note: The WhisperGen must complete a cool down sequence, there is no way to immediately stop the engine.



Warning: In case of fire, use a carbon dioxide or dry powder extinguisher - do not use water.



Note: To cancel auto re-start push the stop button on the control panel.

Setting the Maximum Run Time

If the WhisperGen is started manually or from a remote switch, you can limit the operating duration of the WhisperGen by setting a maximum operating time.

To set the maximum operating time of the WhisperGen:

1. Access the default display on the control panel by pressing < repeatedly. See section entitled Displaying System Information - Displaying Information.

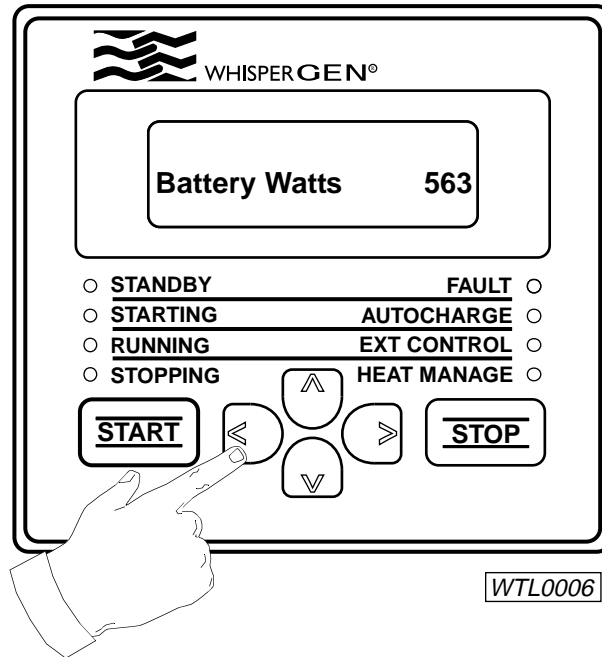

2. Press > to display the first item on the main menu, the **User Menu**

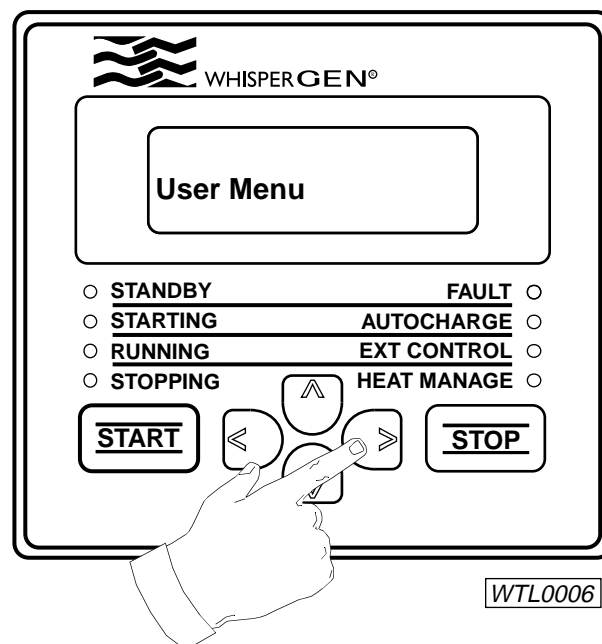

3. Press > to display the first item on the **User Menu**

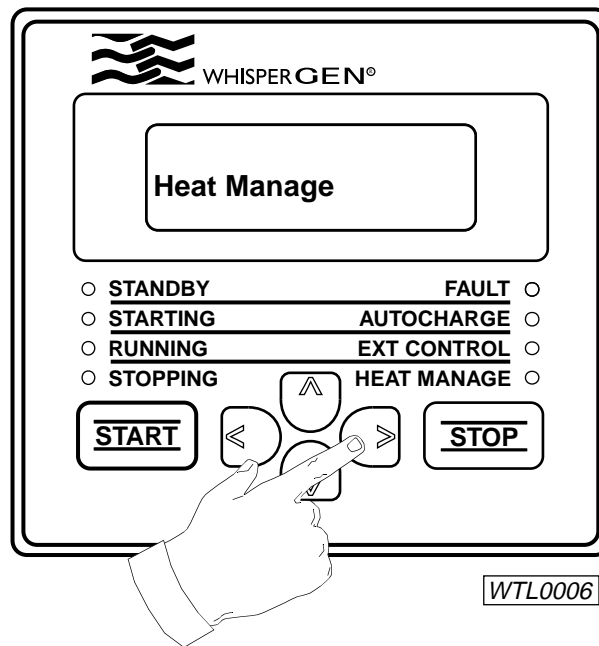

4. Press v to scroll down to **Max Run Hours**.

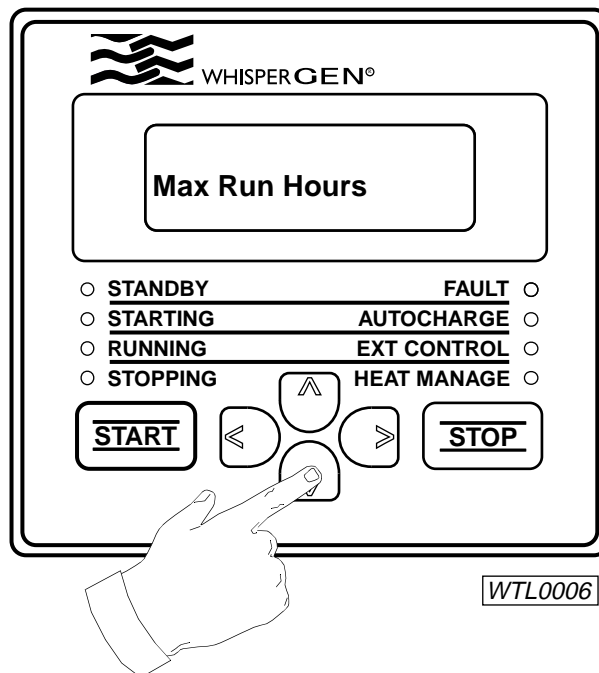

5. Press > to begin editing the maximum operating time of the WhisperGen.

6. Press \wedge or \vee to select the maximum number of operating hours for the WhisperGen. If **25** (hours) is selected, the WhisperGen will run continuously until the battery bank is fully charged.

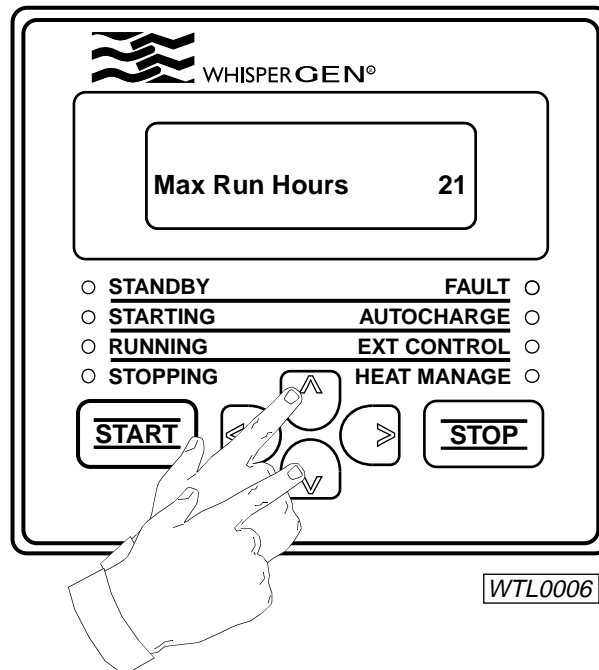

7. Optional: press $<$ repeatedly to return to the default display. You can also let the default display re-appear automatically by allowing a few minutes of inactivity on the control panel.

If the **Max Run Hours** setting is less than **25**, the WhisperGen will automatically stop when the **Max Run Hours** set value is reached, even if the battery bank is not yet fully charged. If the **Max Run Hours** setting is left at its default value of **25**, no maximum operating time condition is imposed: the WhisperGen will run continuously until the battery bank is fully charged.

Note that the **Max Run Hours** setting applies only if the WhisperGen is started manually or from a remote switch. It does not apply if the WhisperGen automatically starts by itself as a result of the auto-charge or heat manage function. For more information on battery bank auto-charging, see section Managing the Battery Bank.

For a summary on operating options, see section Quick Reference - Operating Options.

Remote Controlling

You can start and/or stop the WhisperGen using a remote on/off switch, timer, or thermostat, if one of these is fitted.

To set the remote switch to start/stop the WhisperGen:

1. Access the **User Menu** on the control panel – follow steps 1 to 3 of the procedure outlined in the section entitled Setting the maximum Run Time.
2. Press ∇ to scroll down to **Ext. Control**.

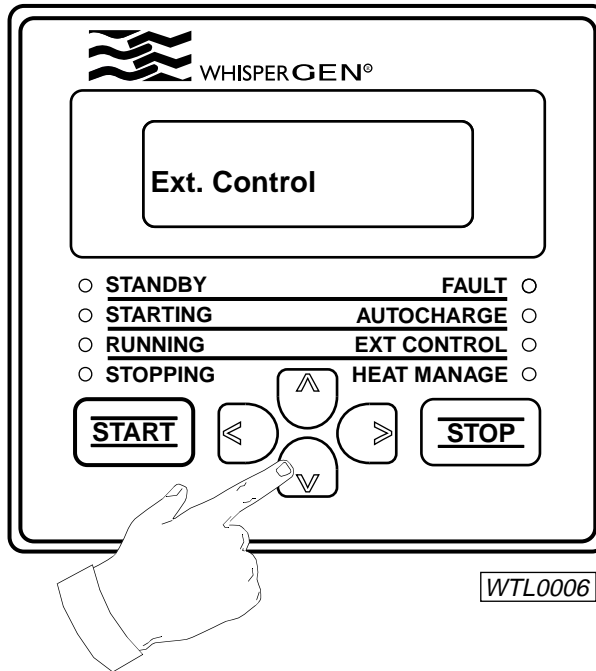

3. Press $>$ to begin editing the external control setting.
4. Press \wedge to select **ON**. The **EXT CONTROL** indicator lights up.

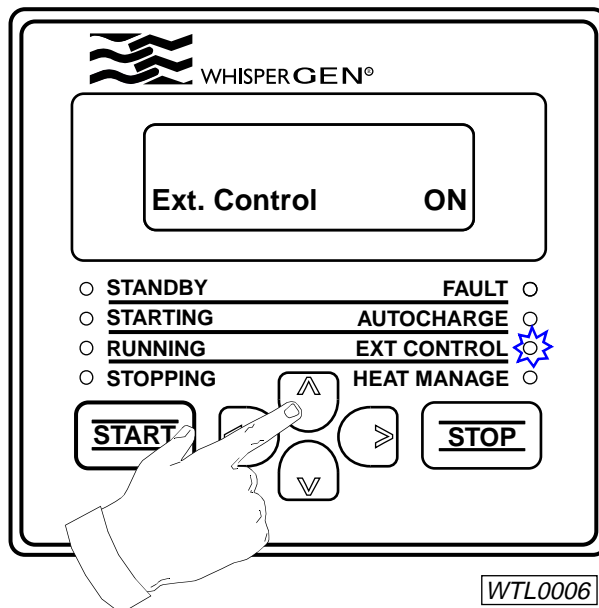

5. Press < to quit editing **Ext. Control**.
6. Press ∨ to scroll down to **Ext Cont Mode**.
7. Press > to begin editing the external control mode setting.
8. Press ^ or ∨ to select an option: **1, 2 or 3**. These options are described in the table below.

Setting	Control Options	Control Logic
1	Starting only	The WhisperGen will start when the remote switch is closed and will continue running even if the remote switch is then opened.
2	Starting and stopping	The WhisperGen will start when the remote switch is closed and stop when it is opened. Once started, the WhisperGen will operate for at least an hour.
3	Stopping only	If the WhisperGen is started while the remote switch is closed, the WhisperGen will stop when the remote switch is opened.

9. Optional: press < repeatedly to return to the default display. You can also let the default display re-appear automatically by allowing a few minutes of inactivity on the control panel.

The effect of starting or stopping the WhisperGen using a remote switch is similar to pressing **START** or **STOP** on the control panel, refer to section entitled Starting the WhisperGen and Stopping the WhisperGen.

For a summary on operating options, refer to the Quick Reference - Operating Options.

Managing the Battery Bank

Stages of Charging

Every time the WhisperGen is operated, it charges the battery bank. There are three stages in a typical charging cycle as shown below:

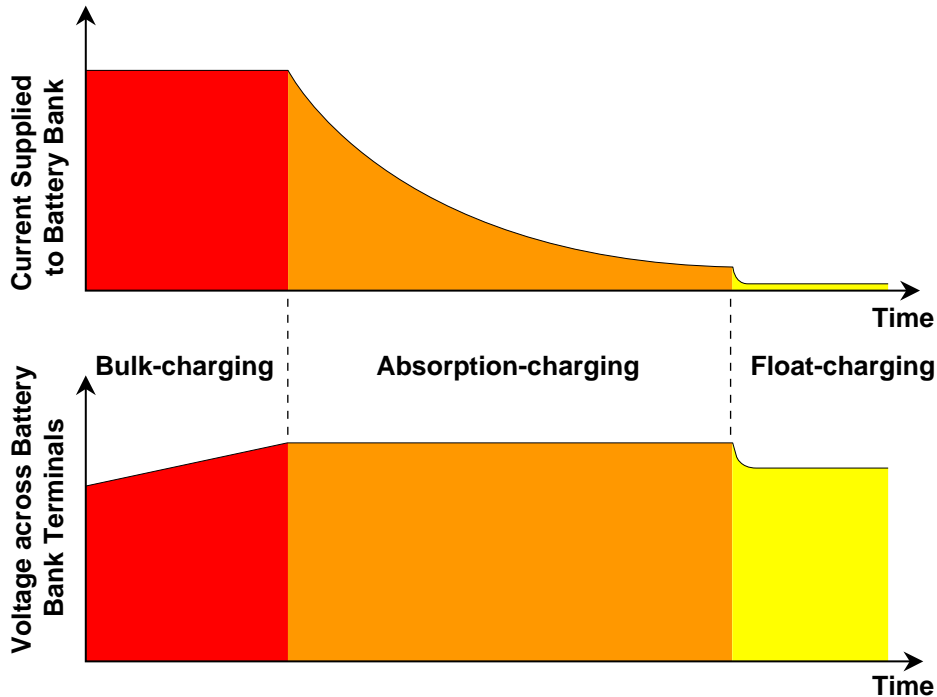

Bulk-charging

The battery bank is charged at the maximum rate. The voltage typically rises 2 or 3 Volts while the current is maintained at a fixed level.

Absorption-charging

The battery bank is about 80% charged at the beginning and the voltage is maintained at a fixed level to fully charge it. The current decreases gradually.

Float-charging

The charged state of the battery bank is maintained with a small current and reduced voltage.

WTL0013

The absorption and float charging voltages, the current level at which absorption-charging ceases, and other battery-charging settings, are set during the installation of the WhisperGen. These settings are set according to the needs of your particular application. If you wish to change these settings, contact your authorised WhisperGen agent.



During the installation of the WhisperGen, some system parameters are set specifically for the particular battery bank that is being used. Before changing the battery bank to a different type or size, consult your authorised WhisperGen agent.

Auto-Charging the Battery Bank

You can set the WhisperGen to automatically start and charge the battery bank when the battery bank charge level is low.

To set the WhisperGen to auto-charge the battery bank:

1. Access the **User Menu** on the control panel – follow steps 1 to 3 of the procedure outlined in section entitled Setting the Maximum Run Time.
2. Press \vee to scroll down to **Auto-charge**.

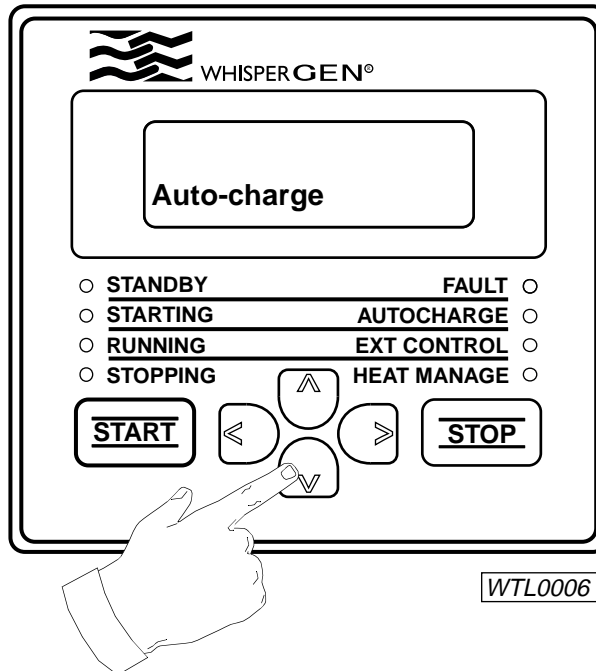

3. Press $>$ to begin editing the auto-charge setting.
4. Press \wedge to select **ON**. The **AUTOCHARGE** indicator lights up.

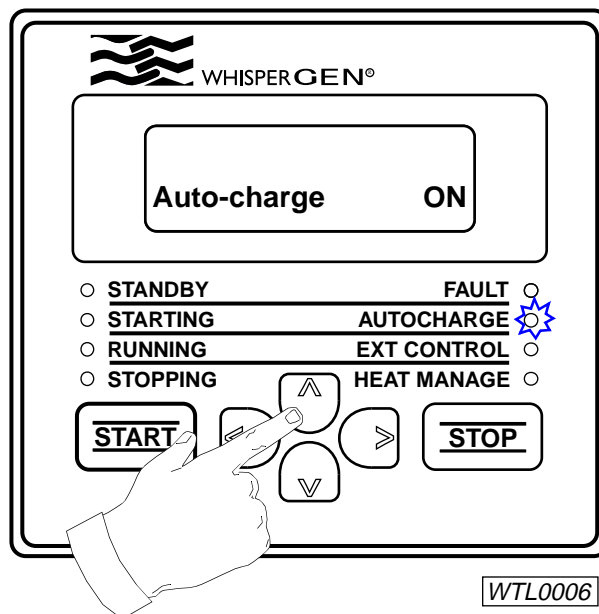

5. Optional: press $<$ repeatedly to return to the default display. You can also let the default display re-appear automatically by allowing a few minutes of inactivity on the control panel.

With the **Auto-charge** option turned **ON**, the WhisperGen will automatically start whenever the battery bank charge level falls below a preset level. This “threshold” level is set during the installation of the WhisperGen according to the needs of your particular application. If you wish to change it, contact your authorised WhisperGen agent.

The battery bank is typically charged in three stages as described in section entitled Stages of Charging. Once the battery bank is fully charged, the WhisperGen stops automatically and returns to the standby mode. Regardless of heat management settings, the WhisperGen will stop once the battery bank is fully charged if the WhisperGen had been started by the auto-charge function.



While the WhisperGen is auto-charging the battery bank, you can stop it at any time by pressing STOP on the control panel. The WhisperGen will however immediately start again if the battery bank charge level is still below the preset level. To prevent the WhisperGen from restarting, turn the Auto-charge option OFF.

If the WhisperGen was started by the auto-charge function, the **Max Run Hours** setting does not affect the operating time of the WhisperGen. Regardless of the **Max Run Hours** setting, the WhisperGen will fully charge the battery bank before stopping.

For a summary on operating options, see section entitled Quick Reference - Operating Options.

Bulk-charging the Battery Bank

While the WhisperGen is running, you can start a new cycle of battery bank charging, that is, return to bulk-charging the battery bank, see section Stages of Charging. This can be done regardless of auto-charging and heat management settings.

To bulk-charge the battery bank while the WhisperGen is running:

Hold down **START** on the control panel until a beep is heard. The control panel will display “Bulk charge”. As an anti-tamper feature, short presses of the **START** key are ignored.

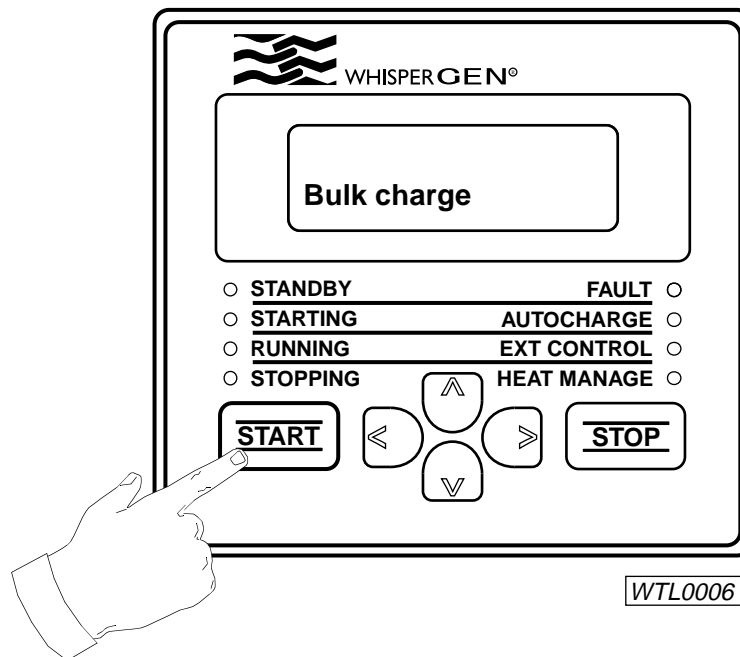

A new charging cycle, beginning with bulk-charging, as described in section Stages of Charging will be started.

Managing Heat Generation

Setting the Coolant Temperature

Whenever it is running, the WhisperGen regulates the temperature of the coolant circulating through it. The coolant is used for space and domestic water heating. By default, the temperature of the coolant is maintained at approximately 60°C. You may however set the coolant temperature to any temperature from 45°C to 70°C.

To set the temperature of the coolant:

1. Access the **User Menu** on the control panel – follow steps 1 to 3 of the procedure outlined in section entitled Setting the Maximum Run Time.
2. Press ∇ to scroll down to **Temp Setpoint**.

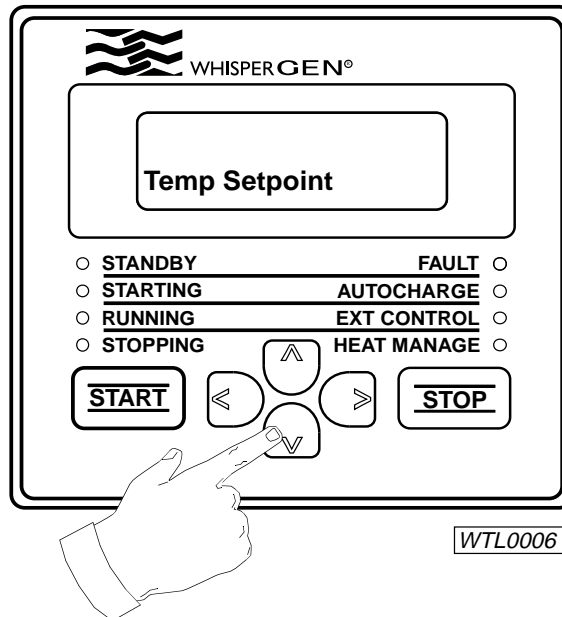

3. Press \triangleright to begin editing the coolant temperature setting.
4. Press \wedge or ∇ to select the coolant temperature. The values shown on the control panel are in °C.

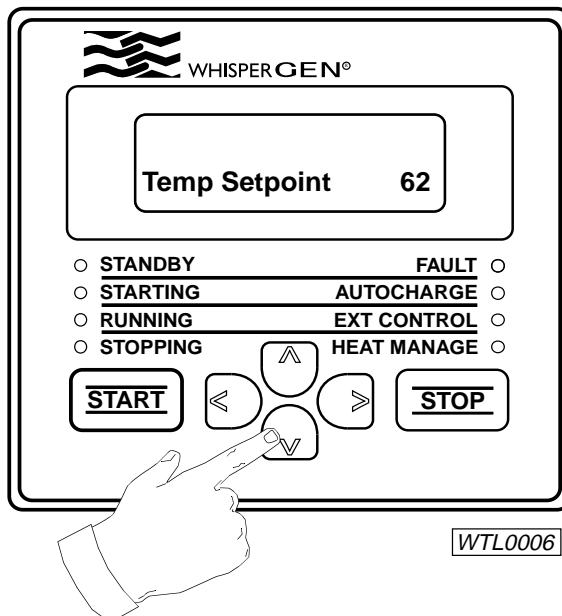

5. Optional: press \triangleleft repeatedly to return to the default display. You can also let the default display re-appear automatically by allowing a few minutes of inactivity on the control panel.

Turning On Heat Management

Whenever it is running, the WhisperGen maintains the coolant temperature at approximately the set point until the battery bank is fully charged. When the battery bank is fully charged, the WhisperGen stops and returns to the standby mode and the coolant temperature is no longer maintained. You can however turn on the heat management option to keep the WhisperGen running to maintain the coolant temperature continuously even after the battery bank has been fully charged.

The WhisperGen will continuously maintain the coolant temperature after the battery bank is fully charged only if the WhisperGen is started manually or from a remote switch. If the WhisperGen starts as a result of the Auto-charge function, the WhisperGen will stop and return to the standby mode once the battery bank is fully charged. For more information refer to section entitled Quick Reference - Operating Options.

To turn on the heat management option:

1. Access the **User Menu** on the control panel – follow steps 1 to 3 of the procedure outlined in section entitled Setting the Maximum Run Time.
2. Press > to begin editing the heat management setting.
3. Press ^ to turn the **Heat Manage** option **ON**. The **HEAT MANAGE** indicator lights up.

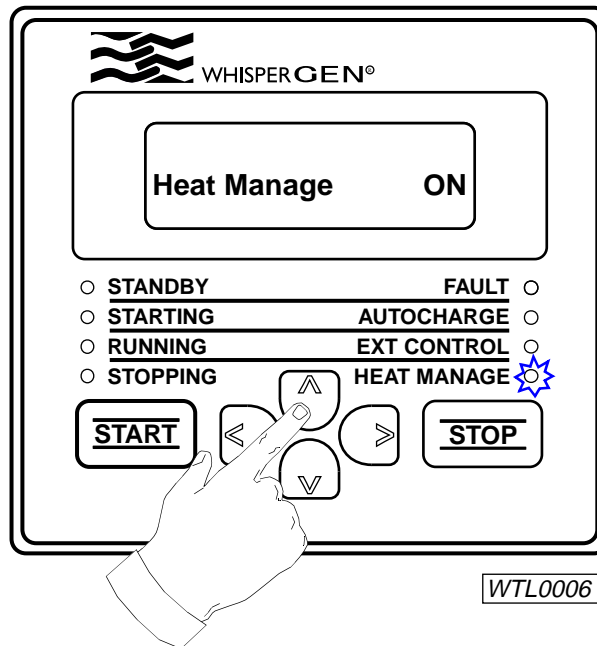

4. Optional: press < repeatedly to return to the default display. You can also let the default display re-appear automatically by allowing a few minutes of inactivity on the control panel.

With the **Heat Manage** option turned **ON**, the WhisperGen, if started manually or from a remote switch, will run continuously and maintain the coolant temperature until it is stopped manually or from the remote switch. If a **Max Run Hours** setting of less than **25** has been set, the WhisperGen will automatically stop when the **Max Run Hours** set value is reached. See section Quick Reference for a summary on operating options.

If the **Heat Manage** option is turned **ON** and an external water heater is connected to the cooling circuit of the WhisperGen, the external water heater will be automatically started to give a rapid initial heat-up of the coolant and to provide supplementary heating whenever required. After the initial heat-up, the external heater will be turned on only if the WhisperGen is unable to maintain the coolant temperature at the set point. The temperatures at which the external heater is started or stopped are preset.

Clearing Faults and Warnings

There are two types of errors that the WhisperGen automatically detects, as described below:

Error Type	Meaning	Indication
Warning	Error that is minor or which indicates that a fault might be developing.	<ul style="list-style-type: none"> The FAULT indicator on the control panel flashes while the error exists. No error message is displayed on the control panel. The WhisperGen continues operating.
Fault	Functional error that causes the WhisperGen to shut down.	<ul style="list-style-type: none"> The FAULT indicator on the control panel is constantly lit. An error message is displayed on the control panel. The WhisperGen shuts down automatically.

Upon detecting a fault, the WhisperGen will shut down, and then automatically clear the fault and attempt to restart. By default, the WhisperGen will attempt to restart once. If you wish to change this setting, contact your authorised WhisperGen agent. Error messages associated with faults from which the WhisperGen cannot recover by itself need to be cleared before normal operation of the WhisperGen may be resumed.

To clear an error message:

1. Physically correct the fault – refer to trouble shooting section for more information.
2. Hold down **START** on the control panel until a beep is heard and the **FAULT** indicator turns off. The WhisperGen does not restart automatically. To restart it, see section entitled Starting the WhisperGen.

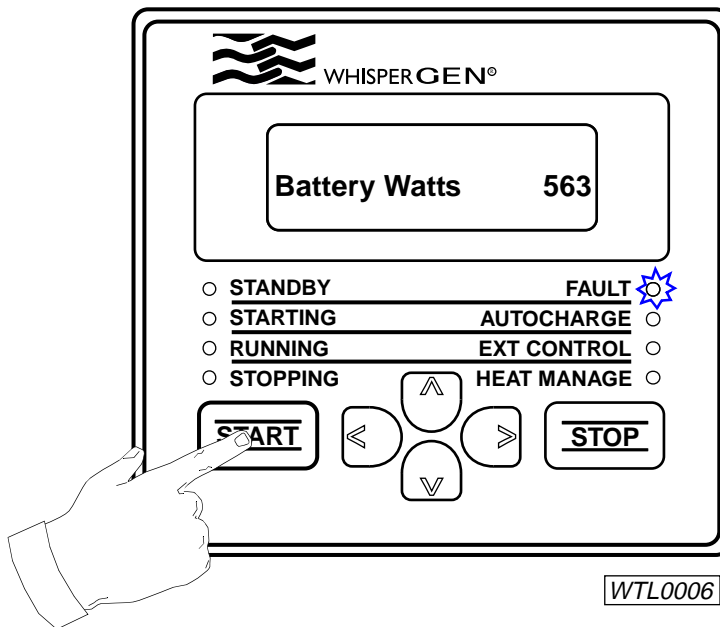

A warning can be cleared even if the physical cause of it has not been corrected. It is possible for the WhisperGen to detect a warning and then subsequently a fault. If this occurs the WhisperGen will attempt to clear the fault and restart itself, the fault needs to be cleared before the WhisperGen can be started again. It is however recommended that the cause of the warning be determined and corrected as soon as possible – see section entitled Trouble Shooting for more information.

When the WhisperGen is started, any warning present is automatically cleared.

To manually clear a warning:

3. Access the main menu on the control panel – follow steps 1 and 2 of the procedure outlined in section entitled Setting the Maximum Run Time.
4. Press \downarrow to scroll down to **Fault/Warning Menu**.

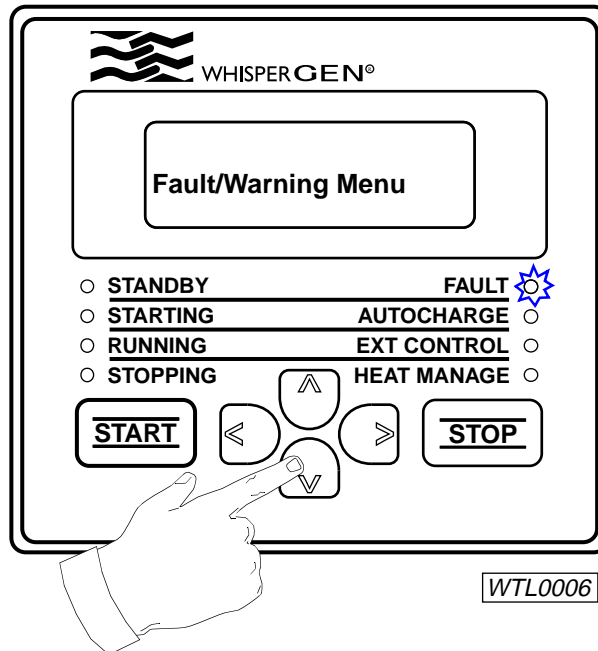

5. Press $>$ to display the first item on the **Fault/Warning Menu**.

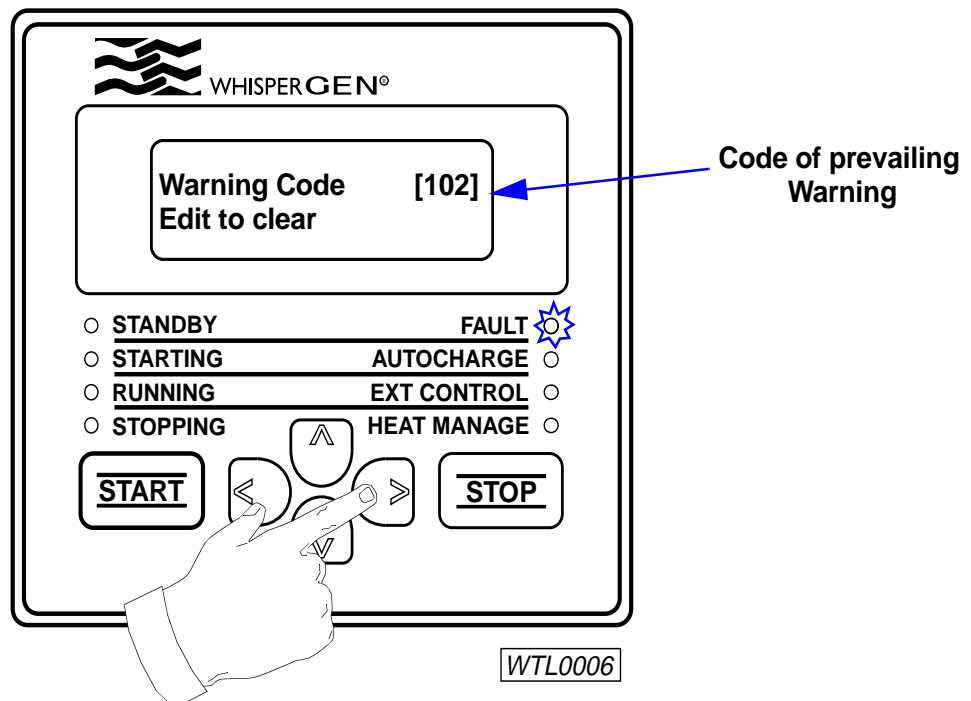

6. Press > to begin clearing the warning.

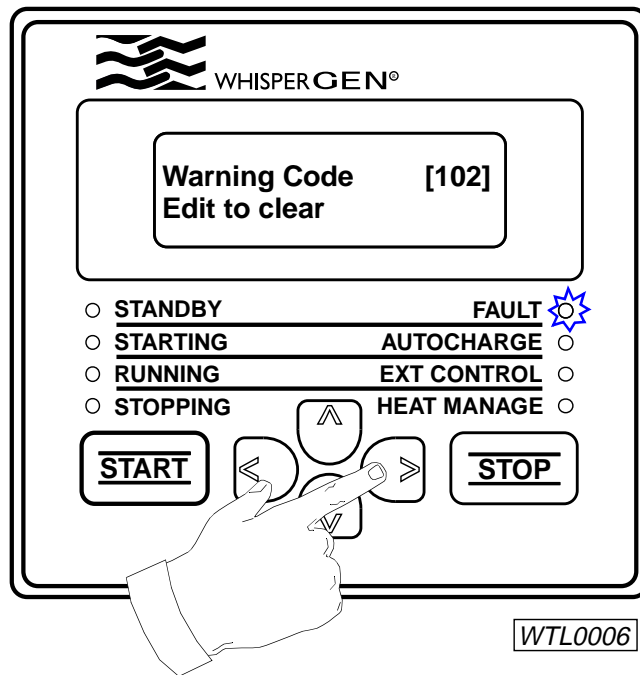

7. Press v to clear the warning. The Fault indicator turns off.

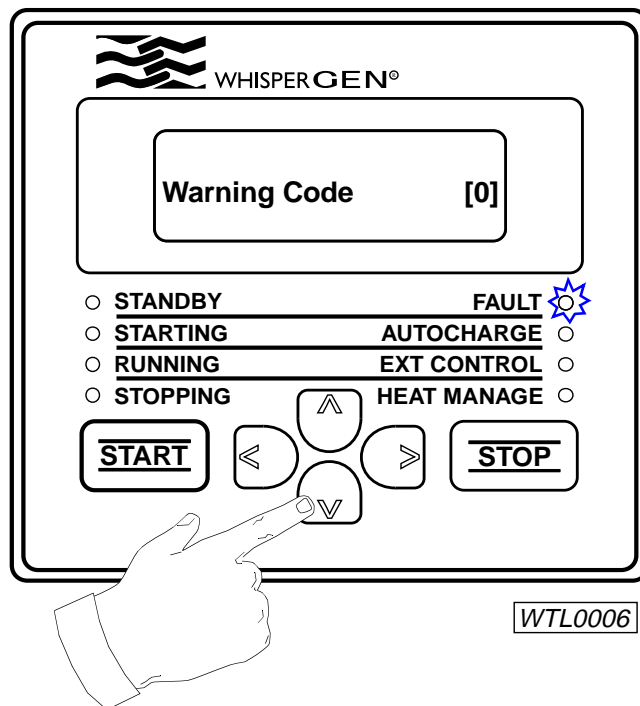

8. Optional: press < repeatedly to return to the default display. You can also let the default display re-appear automatically by allowing a few minutes of inactivity on the control panel.

Adjusting the LCD

Adjusting the Contrast

The control panel has a liquid-crystal display (LCD) which shows system information. The contrast of the LCD can be manually adjusted.

To increase the contrast of the LCD:

Hold down < and ^ repeatedly until the desired contrast is achieved.

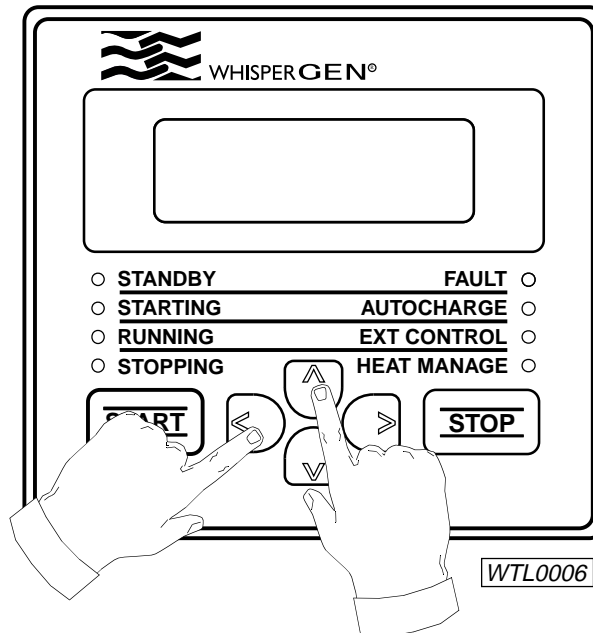

To decrease the contrast of the LCD:

Hold down < and v press repeatedly until the desired contrast is achieved.

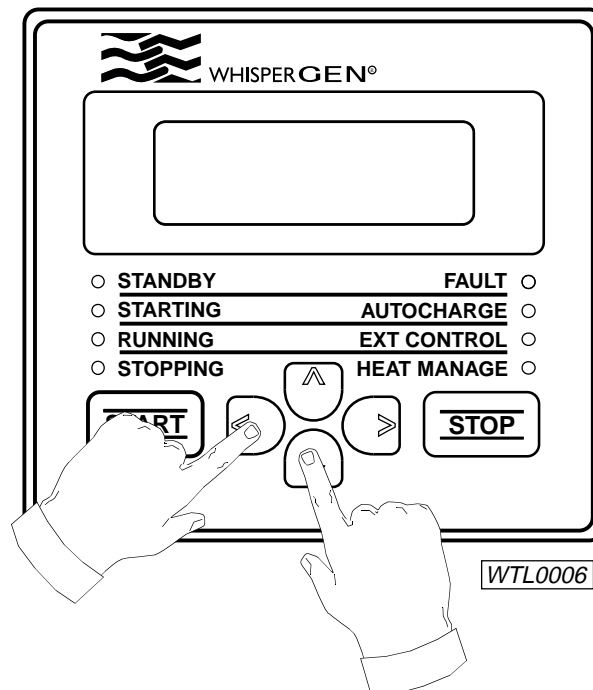

If the battery bank is disconnected from the WhisperGen, LCD contrast settings are retained for up to approximately one month after the disconnection.

Adjusting the Backlight

The LCD has a backlight which allows the LCD to be more clearly seen in dark environments. The backlighting can be manually adjusted.

To adjust the LCD backlight:

1. Hold down < and > press repeatedly until the desired level of backlighting is achieved. Three levels of backlighting are available namely: high, low, and off.

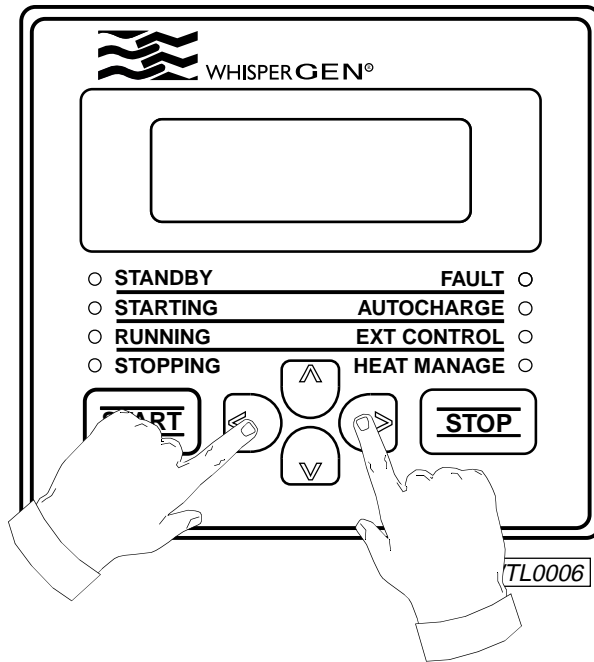

If no keys are pressed, the backlight will be automatically turned off after four minutes. It will be automatically turned on again when a key is pressed. If the battery bank is disconnected from the WhisperGen, backlighting settings are retained for up to approximately one month after the disconnection.

Displaying System Information

Available Information

The control panel displays information regarding the status of the WhisperGen system. The following information, structured as shown in section entitled Quick Reference - Information Structure, may be obtained from the control panel:

Default Display		
Parameter	Meaning	Typical Range
Battery Volts	The voltage across the terminals of the battery bank.	12V battery bank: 9.5 to 15.5 Volts. 24V battery bank: 19.0 to 31.0 Volts.
Battery Amps	The net quantity of electric current in Amperes, flowing through the battery bank. Positive values indicate charging and negative values discharging.	-600 to 200A.
Batt Amp-hrs	The state of battery bank discharge in Ah. A fully charged battery bank is assigned zero Ah.	-700 to 100Ah.
Battery Watts	The quantity of electrical power in Watts supplied to the battery bank. Positive values indicate charging and negative values discharging.	-7000 to 1000 Watts.
Gross Watts	The gross electrical power in Watts, from the WhisperGen generator before power to auxiliary devices such as the air blower and pumps.	200 to 1000 Watts.
Runtime (Min)	The total operating time in minutes since starting.	0 to 999,999 minutes.
Hour Meter	The cumulative number of hours of operation since the WhisperGen was first commissioned. The WhisperGen must be serviced by an authorised WhisperGen agent every 12 months or every 2000 hours of operating time, whichever comes first.	0 to 999,999 hours.
# Of Starts	The cumulative number of times the WhisperGen has started since it was first commissioned.	0 to 999,999.
Warning Code	The code of the prevailing warning, if there is one. A flashing FAULT indicator indicates the presence of a warning. The flashing will stop if the cause of the warning disappears.	100 to 199.

User Menu		
Parameter	Meaning	Typical Range
Heat Manage	The heat management function – see section entitled Turning on heat management.	ON or OFF (default).
Temp Setpoint	The temperature in °C that the coolant is to be maintained at during operation of the WhisperGen – see section entitled Setting the coolant temperature.	45 to 70°C (default is 60°C).
Auto-charge	The Auto-charge function – see section entitled Auto-charging the battery bank.	ON or OFF (default).
Ext. Control	The external or remote control function – see section entitled Remote controlling.	ON or OFF (default).
Ext Control Mode	The mode of operation for the external or remote control switch – see section entitled Remote controlling.	1, 2 (default), or 3.
Max Run Hours	The number of hours of operation after which the WhisperGen is to stop. This parameter setting is a “timer” by which the WhisperGen operates – see section entitled Setting the maximum run time.	1 to 24 hours, or 25 hours for continuous operation (default).

Fault/Warning Menu		
Parameter	Meaning	Typical Range
Warning Code Edit to clear	The current warning code and the warning clearing function – see section 2.8.	100 to 199.
Current Warning	The code of the prevailing warning, if there is one.	100 to 199.
Last Warning	The code of the last warning.	100 to 199.
2nd Last Warning	The code of the warning prior to the last.	100 to 199.
Current Fault	The code of the prevailing fault, if there is one.	2 to 99.
Last Fault	The code of the last fault.	2 to 99.
2nd Last Fault	The code of the fault prior to the last.	2 to 99.
Start Code	The code indicating how the WhisperGen last started. “1” = “manual start”; “2” = “auto-charge start”; “3” = “external control start”.	1, 2, or 3.
Stop Code	The code indicating how the WhisperGen last stopped. “9” = “fault”; “1” = “manual stop”; “2” = “battery charge complete”; “3” = “external control stop”; “4” = “max run hours exceeded”; “5” = “parallel charger turned on”.	9YY, X1, X2, X3, X4, or X5 where YY is the code of the prevailing fault and X is the start code.

Extra Info Menu		
Parameter	Meaning	Typical Range
Alt Current	The electric current in Amperes that is being generated by the WhisperGen alternator. Positive values indicate current generation and negative values current flow to the WhisperGen from the battery bank during cranking.	12V: -20 to 75A. 24V: -10 to 37A.
Air %	The power applied to the air blower as a percentage of the maximum power that can be applied to it. The higher the air flow rate, the higher the combustion rate.	0 to 100%.
Bus Voltage	The voltage across the electrical terminals of the WhisperGen.	12V: 10 to 15.5V. 24V: 20 to 31V.
Coolant Temp	The temperature in °C of the coolant. The coolant temperature reflects the temperature of the engine block.	-10 to 85°C.
Clamp Current	The excess electric current in Amperes being diverted into the “clamp”, an electric water heating element located inside the WhisperGen enclosure.	0 to 70A.
Clamp Voltage	The voltage setting of the “clamp” system.	12V: 12.2 to 16.3V. 24V: 24.85 to 32.7V.
Exhaust Temp	The temperature in °C of exhaust gases between the burner and exhaust heat exchanger.	-10 to 550°C.
FID Current uA	The current in µA flowing between the FID (flame- ionisation detector) electrode and the burner shell. A large current indicates a good stable flame in the burner and correct FID operation.	0 to 10µA.
Fuel Cut Off	The position of the automatic fuel isolation valve located inside the WhisperGen. It should be ON when the WhisperGen is operating.	ON or OFF.
Fuel Metering	The operating state of the fuel pump. It should be ON when the WhisperGen is operating.	ON or OFF.
Fuel Frequency	The rate at which fuel is pulsed into the burner. The fuel pulse rate is adjusted in relation to power demand and the air/fuel ratio.	2 to 16Hz
Glow Plug	The operating state of the glow plug. The glow plug is turned ON as required during the start-up of the burner.	ON or OFF.

Extra Info Menu		
Parameter	Meaning	Typical Range
Isolate Relay	The position of the main electrical isolator relay located inside the WhisperGen. It should be ON when the WhisperGen is operating.	ON or OFF.
Power Relay	The power supply to ancillary components such as the fuel pump, coolant pump, etc. The power supply should be ON when the WhisperGen is operating.	ON or OFF.
O2 Value	The quantity of oxygen in the exhaust. This reflects the air/fuel ratio.	200 to 2500.
O2 Ave Error	The averaged difference between the air/fuel ratio set point and the actual ratio. The smaller the difference, the more stable the burner.	2 to 400.
Software Ver	The version of software the WhisperGen is operating on.	A five-digit number.

Installation Menu		
Parameter	Meaning	Typical Range
Heat exchanger Nozzle Bleed	Spraying water through the heat exchanger to clean internal cavities.	On for 1 sec.
Air Bleed	Blowing air through the burner and exhaust system.	ON or OFF (default).
Fuel Bleed	The fuel bleeding function – see section entitled Bleeding the Fuel Line. The water pumps may start when the fuel line is bled.	ON or OFF (default).
Coolant 1 Bleed	The coolant bleeding function – see section entitled Bleeding the Coolant Circuit.	ON or OFF (default).
Coolant 2 Bleed	The seawater and coolant bleeding function – see section 3.8.	ON or OFF (default).
Enable Starts	The function that enables or disables WhisperGen starts during maintenance or servicing. “0” = “no starts allowed”; “1” = “allow manual starts only”; “2” = “allow all manual and automatic starts”.	0 (default), 1 or 2.

Displaying Information

Information displayed on the control panel is structured as shown in the section entitled Quick Reference - Information Structure. The default display is the highest level on the information structure. If no keys are pressed for a few minutes, the control panel defaults to the last displayed parameter on the default display.

To access the default display at any time:

1. Press < repeatedly until one of the default display parameters appear. For example, if **Alt Current** (a parameter of the "extra info" menu) is initially displayed, pressing < twice returns to the default display.

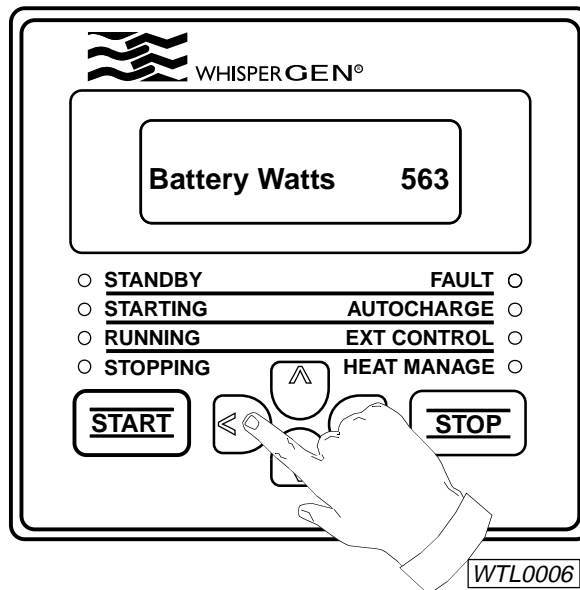

To display a menu at a lower level:

2. Press >. For example, if **Battery Volts** (a parameter in the default display) is displayed initially, then to display the main menu, press > once as shown.

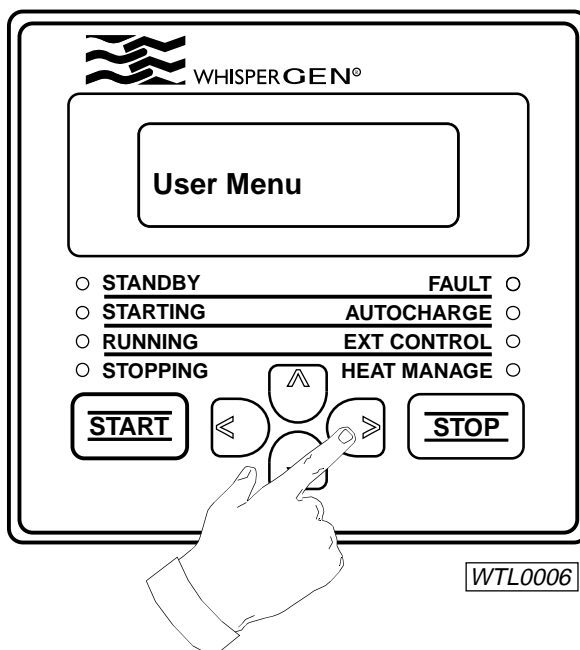

To display a menu at a higher level:

3. Press <. For example, if **Alt Current** is displayed initially, then to display the main menu, press <.

To scroll up within a menu:

4. Press ^ . For example, if **Bus Voltage** is displayed initially, then to display **Alt Current**, press ^ twice.

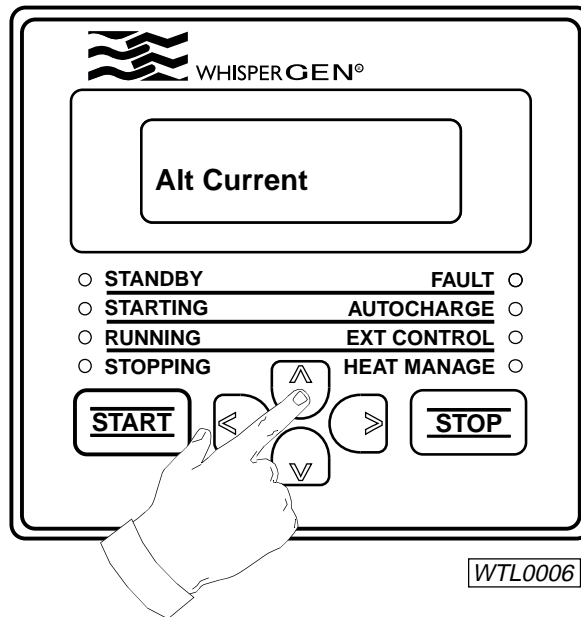

To scroll down within a menu:

5. Press v. For example, if **Alt Current** is displayed initially, then to display **Coolant Temp**, press v three times.

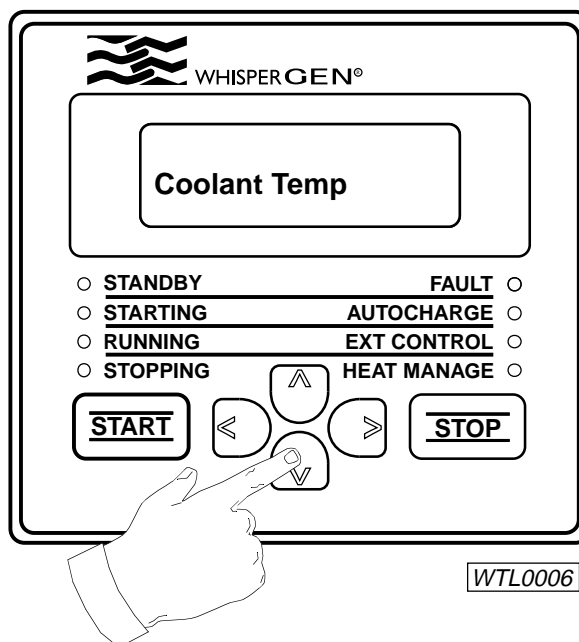

Editing Parameter Settings

Information displayed on the control panel is structured as shown in section entitled Quick Reference. The settings of all the parameters under the **User Menu** and **Installation Menu** can be edited. The **Warning Code Edit to clear** parameter under the **Fault/Warning Menu** can also be edited. All other parameter settings can be displayed but not edited.

To edit the setting of a parameter:

1. Display the parameter on the control panel – see section entitled Displaying System Information - Displaying Information. For example, if you wish to edit the battery bank auto-charging setting, then display **Auto-charge** on the control panel by pressing > twice followed by v twice from the default display.

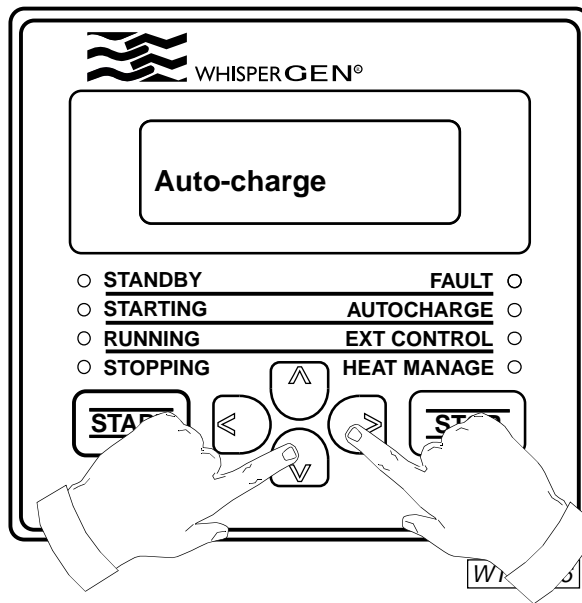

2. Press > to begin editing the setting of the parameter. The existing setting of the parameter will be displayed. In the above example, either **ON** or **OFF** will be displayed, depending on the existing setting of **Auto-charge**.

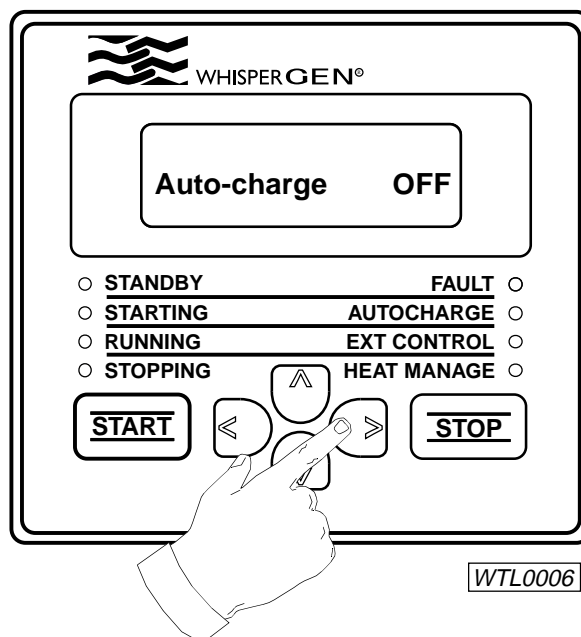

3. Press \wedge or \vee to edit the setting. In the above example, if the existing setting is **OFF** and you wish to turn on auto-charging, then press \wedge to change the setting to **ON**.

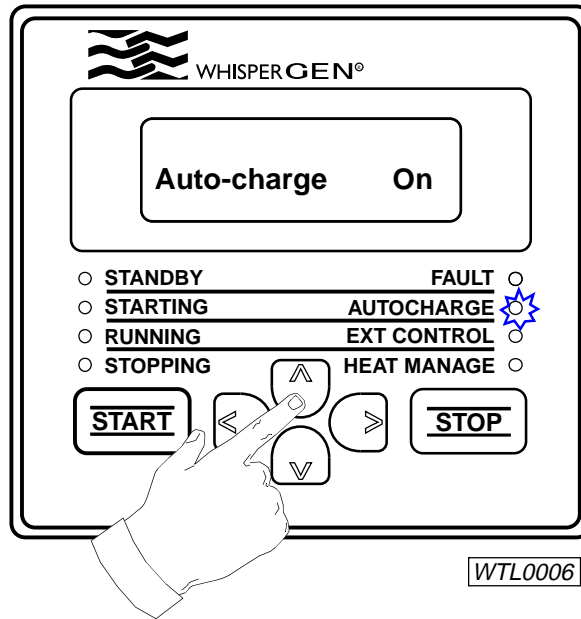

4. Optional: press \leftarrow repeatedly to return to the default display. You can also let the default display re-appear automatically by allowing a few minutes of inactivity on the control panel.

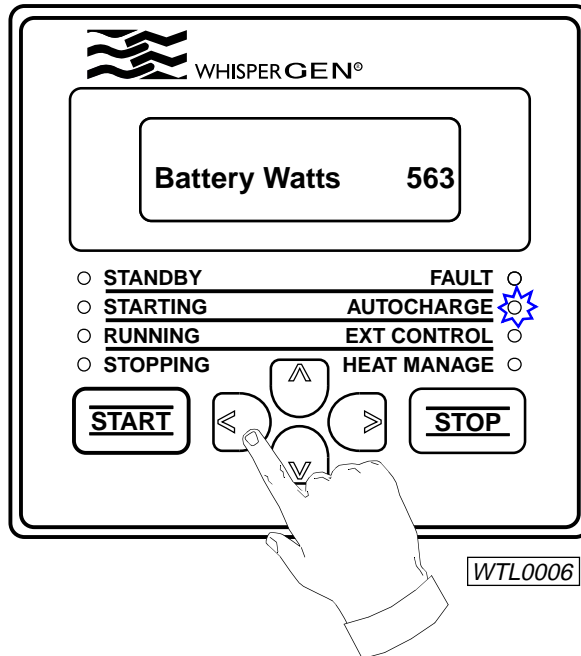

Maintenance

Introduction

This section outlines maintenance procedures for your WhisperGen. It will show you how to:

- Develop a basic maintenance routine for the WhisperGen;
- Maintain the fuel and coolant systems;
- Check the battery bank connections; and
- Replace the glow plug, fuses, FID, oxygen sensor, and evaporator.



You should read and understand all safety precautions before operating or maintaining your WhisperGen. For spare parts kit supplied, refer to your authorised WhisperGen service agent for further details.



Before carrying out maintenance, the Enable Starts option in the Installation Menu should be set to 0 to prevent unintentional starts of the WhisperGen. Reset to either 1 or 2 (depending on the user setting requirement) after maintenance has been completed. For information on how to edit settings, refer to section entitled Displaying System Information - Editing Parameter Settings.

Maintenance Schedule

The following maintenance procedures must be performed on the WhisperGen on a regular basis as recommended below:

Procedure	How	When
Checking the coolant.	See section - Checking the Coolant.	Depends on the coolant circuit; at least once a month.
Checking battery bank connections.	See section - Checking battery bank connections.	Every three months.
General checking.	See section - General checking.	Every six months.
Flushing the exhaust heat exchanger	See section - Flushing the exhaust heat exchanger	Every three months.

In addition to the procedures above, you should also contact your authorised WhisperGen service agent to check the WhisperGen every 12 months or every 2000 hours of operating time.



If service checks are not performed by an authorised WhisperGen service agent every 12 months or 2000 hours of operating time from the date of commissioning, the warranty on the WhisperGen will be void.



When performing any maintenance work on the WhisperGen, refer to the applicable sections when removing or replacing parts and stopping or starting the WhisperGen.

The following procedures may need to be carried out if faults develop:

Procedure	How	When
Bleeding the fuel line.	See section - Bleeding the fuel line.	<ul style="list-style-type: none"> When there is air trapped in the fuel line. After a fuel run-out occurs. After the fuel filter is cleaned.
Cleaning the fuel pump filter.	See section - Cleaning the fuel pump filter.	<ul style="list-style-type: none"> When fuel supply faults arise. When the power output is constantly low.
Bleeding the coolant circuit.	See section - Bleeding the coolant circuit.	When there is a coolant flow fault.
Replacing the glow plug.	See section - Replacing the glow plug.	When a glow plug circuit fault arises and the glow plug fuse is not blown.
Replacing fuses.	See section - Replacing fuses.	When fuses are blown.
Replacing the FID.	See section - Replacing the FID	When ignition or flame faults occur repetitively.
Replacing the oxygen sensor.	See section - Replacing the oxygen sensor.	<ul style="list-style-type: none"> When oxygen sensor faults arise. If burner or flame faults occur despite FID replacement.
Replacing the evaporator.	See section - Replacing the evaporator.	If burner, ignition, or flame faults occur despite FID and/or oxygen sensor replacement.

For all WhisperGen faults and maintenance procedures not listed in this manual, please contact your authorised WhisperGen service agent for assistance. A list of WhisperGen faults that may arise and how they may be remedied is given in the Trouble shooting section.



When maintaining or troubleshooting the WhisperGen, you should perform only the procedures recommended in this manual. If you perform procedures other than those recommended in this manual, you may cause injury or equipment damage, and the warranty on the WhisperGen will be void.

Removing the Enclosure Lid

The enclosure lid protects the internal parts of the WhisperGen and is held in place by two rubber rings. Some maintenance and troubleshooting procedures require the enclosure lid to be removed.

To remove the enclosure lid:

1. Remove the rubber rings from the upper plastic hooks on both sides of the WhisperGen.

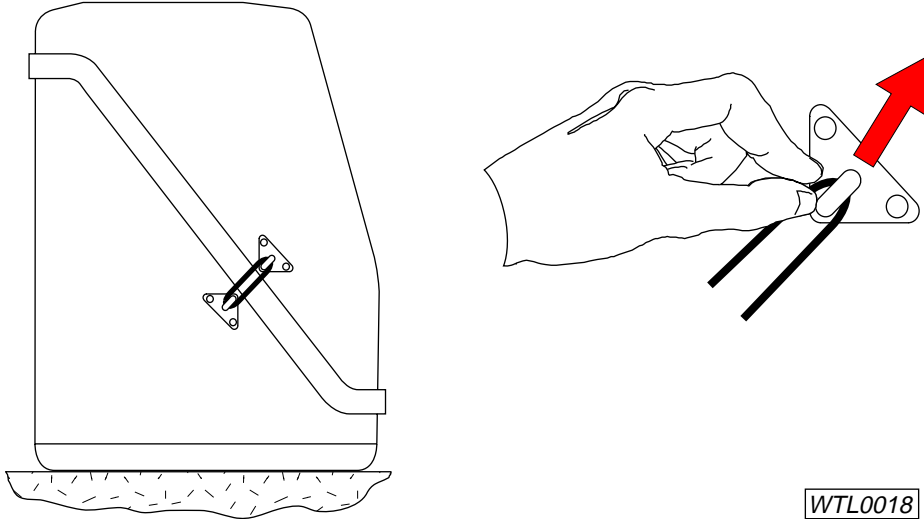

2. Carefully lift the enclosure lid.

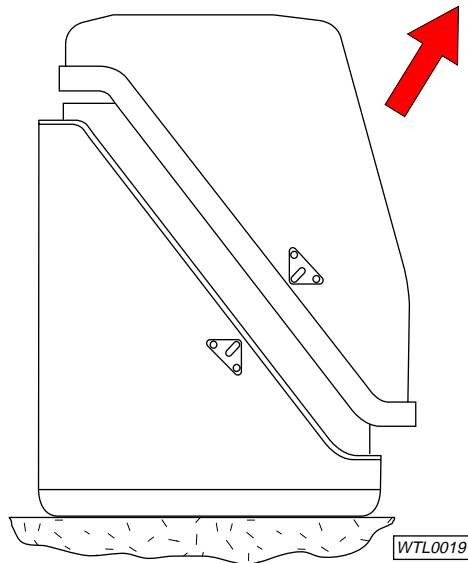

Do not touch the surfaces that are labelled as hot and do not operate the WhisperGen without the enclosure lid on for more than 10 minutes as air circulation through the WhisperGen will be disrupted.

When replacing the lid, hook it over the back of the enclosure base and swing it down over the front. **Ensure the lid is well seated on the rubber seal.** Then connect the rubber rings to the hooks.

General Checking

The following general checking routine helps to ensure the proper functioning of the WhisperGen and should be performed every six months.

1. Start the WhisperGen.
2. Check that the WhisperGen exhaust does not contain high levels of smoke. When the WhisperGen first starts, smoke may be released initially. However, only steam should be visible several minutes after the WhisperGen has started.
3. Check all exhaust piping in occupied areas for leakage. You should not smell fuel fumes in occupied areas. If in doubt, apply soapy water on exhaust piping joints to check for exhaust gas leakage.
4. Check all coolant piping for leakage.
5. Check the coolant level.
6. Check all fuel piping for leakage.



The rest of the steps below must be completed in 10 minutes or less. The WhisperGen should not be operated without the enclosure lid for prolonged periods.

7. Remove the WhisperGen enclosure lid.



Do not touch the surfaces that are labelled as hot.

8. Check for smoke emissions from within the WhisperGen enclosure. There should not be smoke emitted from inside the WhisperGen and you should not smell diesel fumes.
9. Check for fuel and coolant leakage inside the WhisperGen enclosure. Fluids and white residue deposited at the bottom of the WhisperGen enclosure are often an indication of leakage.
10. Check for abnormal noises. There should not be excessive rattling sounds.
11. Check that the rubber hoses and the external red burner seal are not cracked or worn.
12. Check the battery bank connections.
13. Check that the drain holes in the bottom corners of the enclosure base are not blocked.
14. Remove, with a vacuum cleaner, dust accumulated on the inside of the WhisperGen, particularly on the front louvres of the electronics enclosure.
15. Replace the enclosure lid.
16. Check that the condensate drain hose is clear of debris and obstructions.

If you find any abnormalities, whether inside or outside the WhisperGen, contact your authorised WhisperGen service agent immediately. The contact details for your authorised WhisperGen service agent appear at the back of this manual.



Do not attempt to do any repairs that are not authorised in this manual.

Checking the Fuel

The fuel level should be checked regularly to ensure a constant fuel supply to the WhisperGen. How often the fuel needs to be checked and replenished depends on the operating conditions of the WhisperGen and the size of the fuel tank. In general, the WhisperGen consumes 0.5 to 0.85 litres of fuel per hour of operation. This applies to machines using either diesel or kerosene fuel.

To check the fuel level:

1. Remove the fuel tank cap. The fuel tank is located outside the WhisperGen and is typically within five metres of it.
2. Ensure that the fuel level is adequate. The fuel level must be higher than the fuel outlet point at all times.

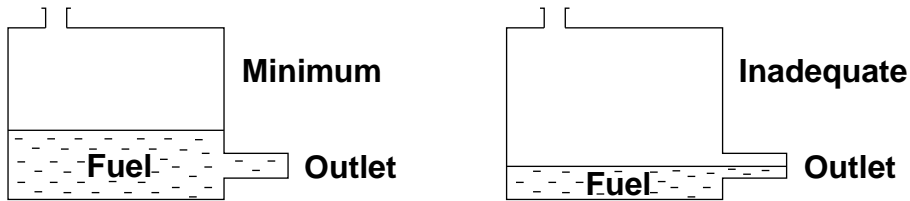

WTL0020

3. Replenish fuel if necessary, taking care not to spill any on or in the vicinity of the WhisperGen.

For WhisperGen's equipped with diesel burners.



Use only good quality automotive diesel (EN590 or BS2869: 2000 burner fuel class A2, D, minimum flash point, closed, 56°C). Do not use other fuel types such as bio diesel, heating oil, petrol, aviation fuel, and LPG.

For WhisperGen's equipped with kerosene burners.



Use only good quality kerosene oil (BS2869: 2000 class C1, or C2 burner fuel, minimum flash point, closed, 43°C for C1, 38° C for C2). Do not use other fuel types such as heating oil, petrol, aviation fuel, and LPG.

4. Replace the fuel tank cap.

If the fuel tank was empty and a fuel-related error message is displayed on the control panel, you will need to bleed the fuel line before the WhisperGen can be operated normally again.

Bleeding the Fuel Line



Filling a fuel tank that has run empty may introduce into the fuel line air bubbles that could cause the WhisperGen to malfunction. After filling an empty fuel tank, you must bleed the fuel line to remove any air bubbles that might be trapped in it.



The coolant and seawater pumps may start when the fuel line is bled. (marine version only)

To bleed the fuel line:

1. Stop the WhisperGen and wait until the **STANDBY** indicator on the control panel is lit.



To prevent unintentional starts of the WhisperGen, heed the warning given at the beginning of this section.

2. Remove the enclosure lid and wait for the engine to cool.



Do not touch the surfaces that are labelled as hot.

3. Turn on the WhisperGen fuel valve.

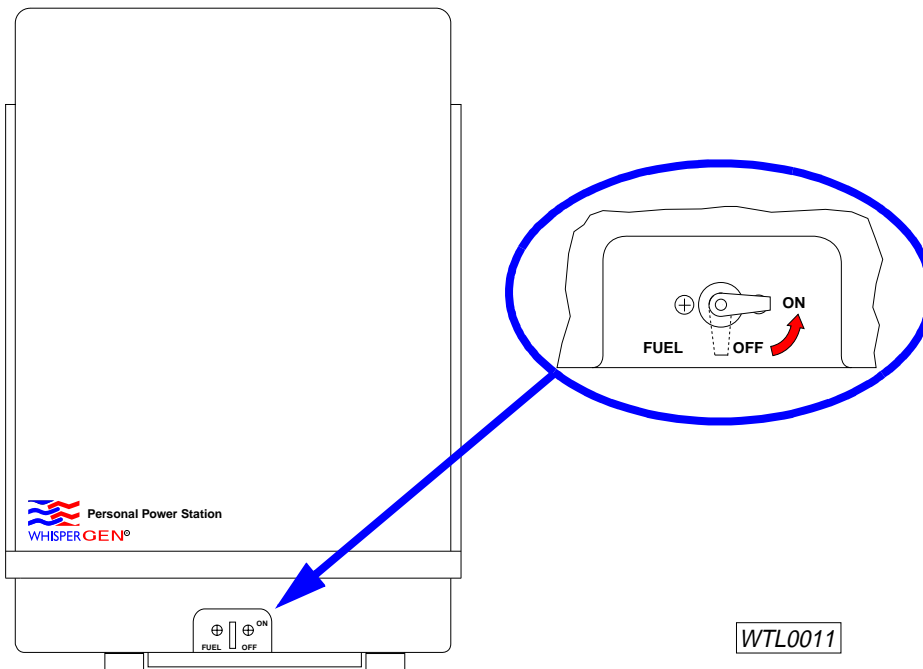

4. Uncrew the fuel line fitting on top of the burner.

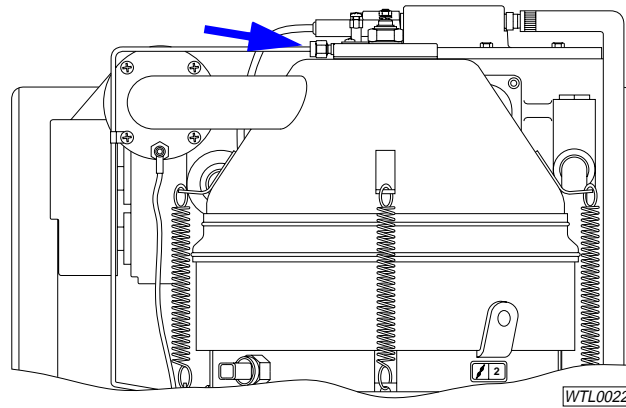

5. Connect a clear plastic hose to the exposed end of the fuel line, and allow the hose to drain into a container that will hold at least a litre of fuel.

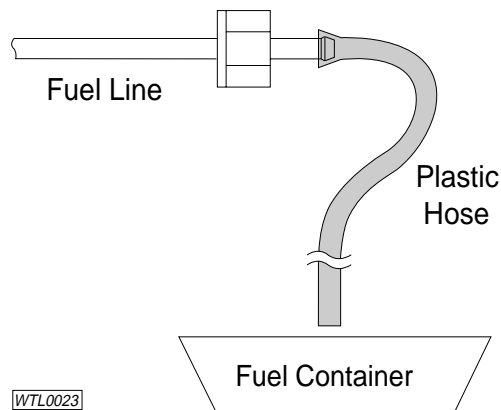

6. Access the Main Menu on the control panel - follow the first two steps of the procedure outlined in the section entitled Stopping the WhisperGen - Setting the maximum run time.
7. Press ∇ to scroll down to Installation Menu.

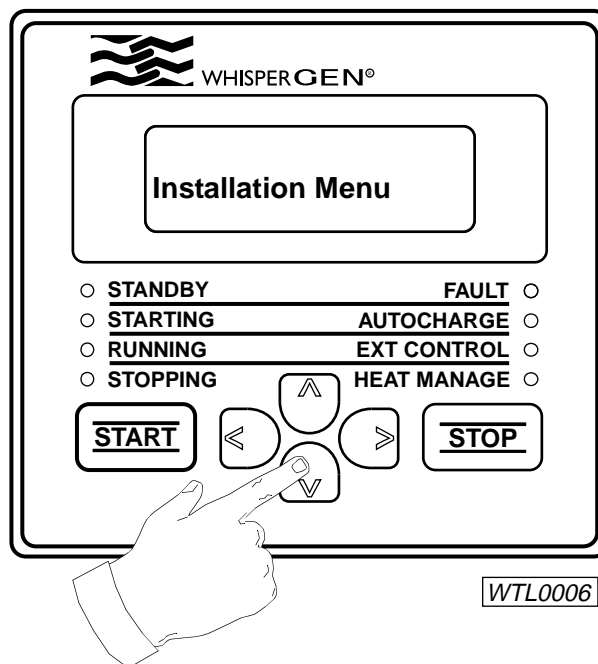

- Press > to display the third item on the Installation Menu, Fuel Bleed.

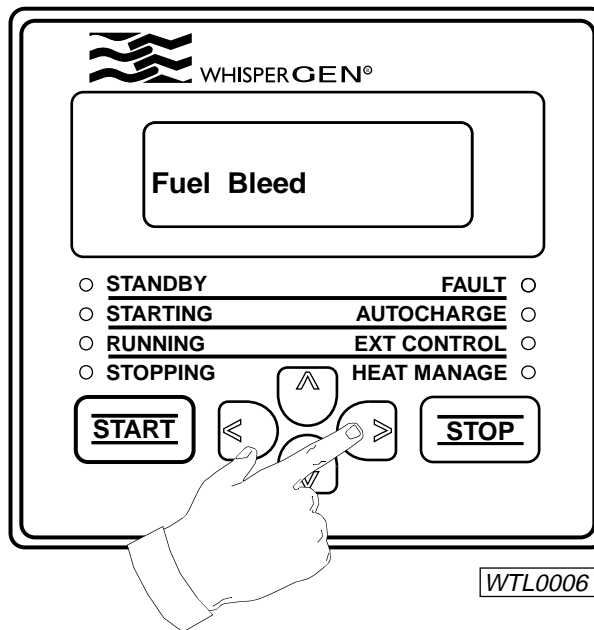

- Press > to begin editing the fuel bleeding setting.
- Press ^ to select **ON**. Fuel will be bled through in pulses for 60 minutes. You can stop the fuel pump at any time by pressing v. At least twice the volume of fuel in the entire fuel line connecting the fuel tank to the evaporator must be bled. For example, if the fuel line measures 3mm in inner-diameter and 5m in length, then 70ml of fuel must be bled.

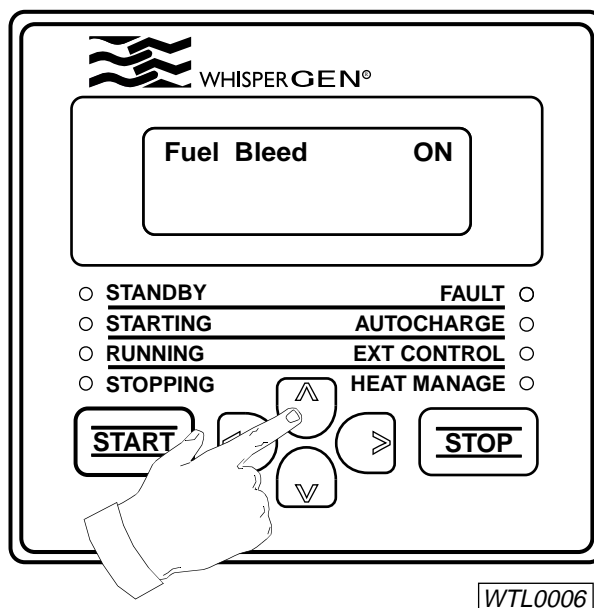

- Optional: press < repeatedly to return to the default display. You can also let the default display re-appear automatically by allowing a few minutes of inactivity on the control panel.
- Reconnect the fuel line to the evaporator. Finger tighten the nut against the shoulder. Using a spanner tighten $\frac{3}{4}$ turn only.
- Ensure that there is no leakages.
- Replace the enclosure lid.

The WhisperGen may now be started as required.

Cleaning the Fuel Pump Filter

Fuel supplied to the WhisperGen must have low levels of contamination. The fuel filter inside the fuel pump should be cleaned if faults related to fuel supply occur frequently or if the power output is constantly low.

To clean the fuel filter:

1. Turn off the fuel tank valve and the WhisperGen fuel valve.

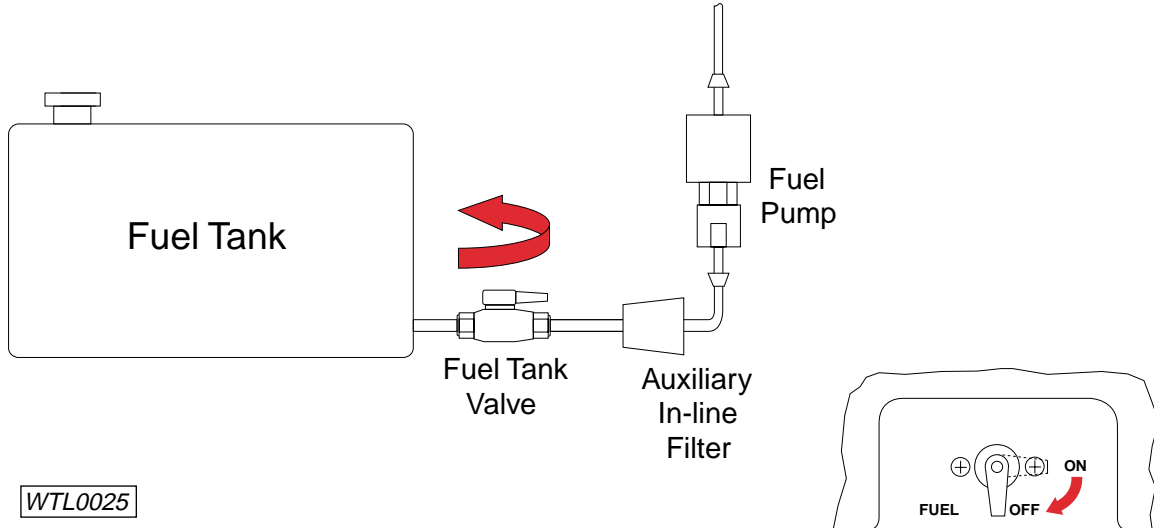

2. Place a container below the fuel pump to collect fuel spillage.
3. Remove the fuel line from the brass end of the fuel pump.

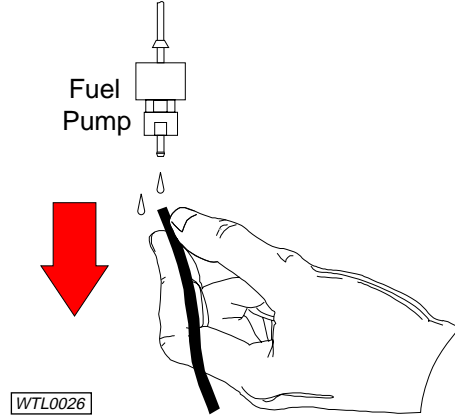

4. Undo the cylindrical brass fitting.

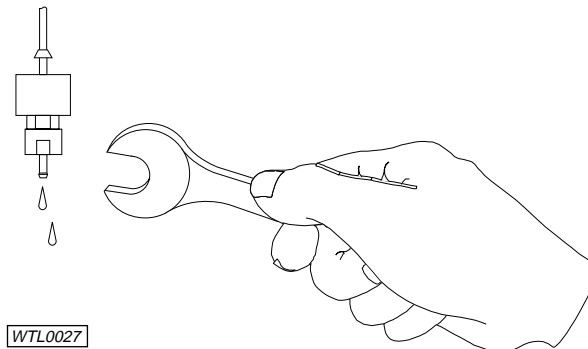

-
5. Remove the filter from the fuel pump.

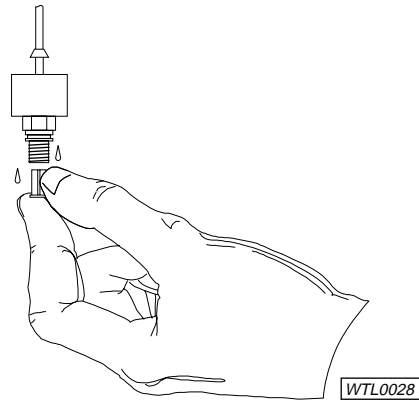

6. Clean the filter by either blowing clean compressed air through it or by brushing it in clean diesel or kerosene. Do not use a cloth rag to clean or dry the filter.

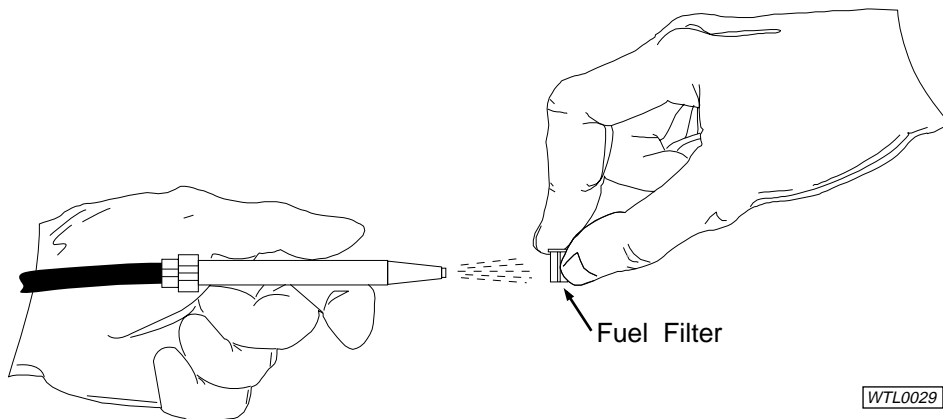

7. Replace the filter in the brass fitting and secure the brass fitting to the fuel pump, making sure that the o-ring is correctly seated.
8. Secure the fuel line to the fuel pump.
9. Turn on the fuel tank and WhisperGen fuel valves.
10. Bleed the fuel line.
11. Check that there is no fuel leakage.

If there is another fuel filter installed external to the fuel pump, it should be cleaned also – follow the instructions provided by the WhisperGen service agent who installed the external filter.

Checking the Coolant

The coolant level should be checked regularly to ensure a constant circulation of coolant through the WhisperGen. How often the coolant needs to be checked and replenished depends on the size of the coolant header tank and the coolant circuit. In general, you should check the coolant level at least once a month.



The cooling system of the WhisperGen is vital to its performance. If the coolant level is not maintained correctly, damage may occur.

To check the coolant level:

1. Remove the coolant header tank cap. The WhisperGen coolant header tank is located outside the WhisperGen and is typically mounted at a level above the WhisperGen.
2. Ensure that the coolant level is adequate. The coolant level must be higher than the outlet point at all times.

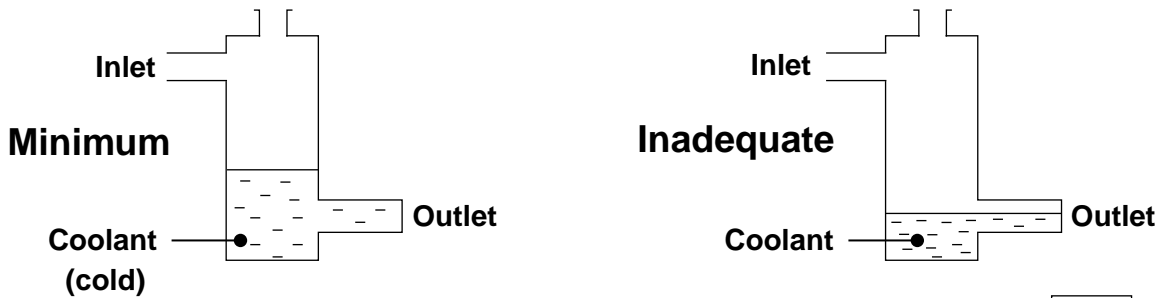

3. Replenish coolant if necessary. Use a high-quality automotive glycol-based corrosion-inhibited antifreeze that is designed for aluminium engines. Follow the dilution recommendation of the manufacturer.



Ethylene glycol is harmful if swallowed or inhaled. Do not store it in open or unlabelled containers. Wash your hands thoroughly after handling it.



Using an incorrect type of coolant can cause serious corrosion in the WhisperGen – use only the recommended coolant.



Ensure that the coolant is free of particulate contaminants. Foreign particles in the coolant can obstruct coolant passages in the engine, resulting in damage to the WhisperGen.

4. Replace the coolant header tank cap.

Bleeding the Coolant Circuit



Filling a coolant header tank in which the coolant level has fallen below the outlet level of the tank, may introduce into the coolant circuit air bubbles that could cause the WhisperGen to malfunction. Should this occur bleed the coolant circuit.

To bleed the coolant circuit:

1. Stop the WhisperGen and wait until the **STANDBY** indicator on the control panel is lit.



To prevent unintentional starts of the WhisperGen, heed the warning given at the beginning of this section.

2. Remove the enclosure lid and wait for the engine to cool.



Do not touch the surfaces that are labelled as hot.

3. Access the **Main Menu** on the control panel - follow the first two steps of the procedure entitled Setting the Maximum Run Time.
4. Press ∇ to scroll down to **Installation Menu**.

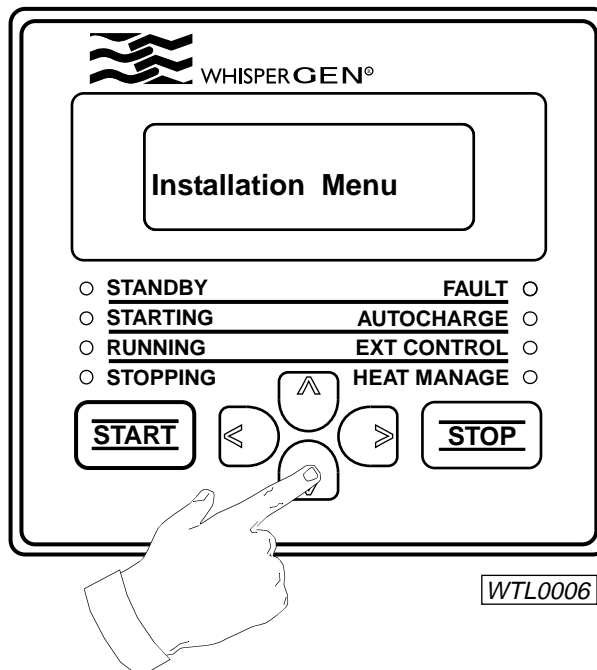

5. Press > to display the first item on the **Installation Menu**.

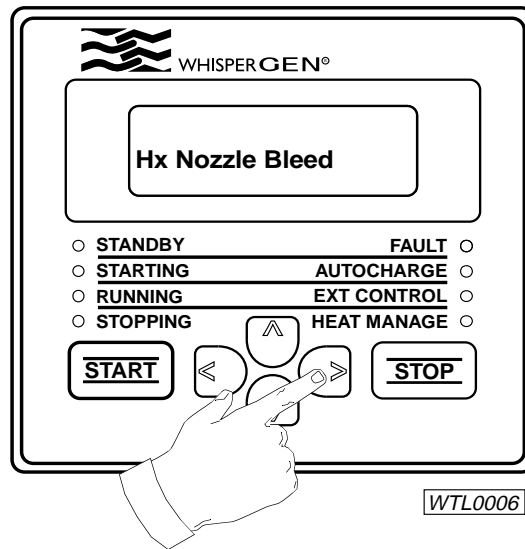

6. Press v to scroll down to **Coolant Bleed 1**.

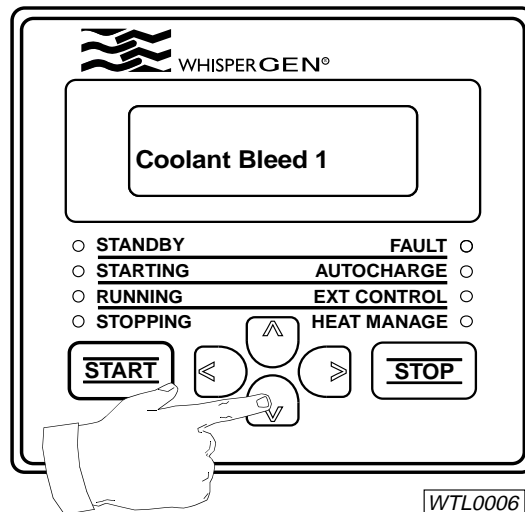

7. Press > to begin editing the coolant bleed setting.

8. Press ^ to select **ON**. the coolant pump will be turned on to bleed the coolant circuit.

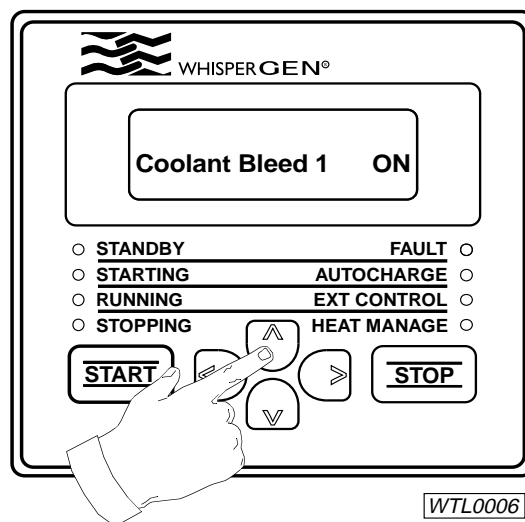

9. Get a clean rag ready.
10. Open the coolant-bleeding valve with a 6mm hex socket (or with a suitable key). Use the rag to absorb the coolant bleeding out.

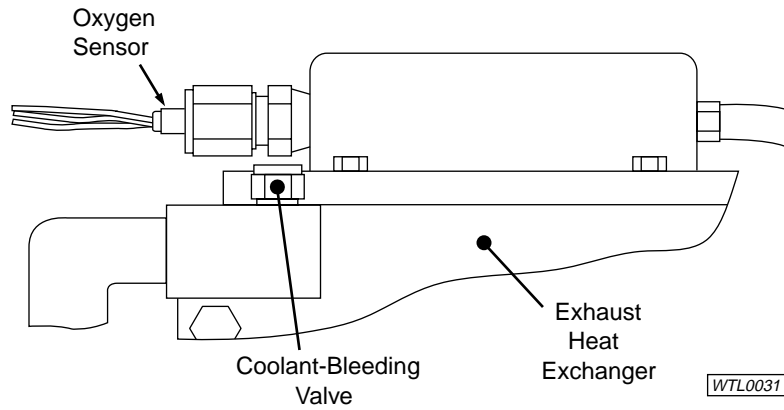

11. After the coolant pump has been running for five minutes, press √ to turn it off.

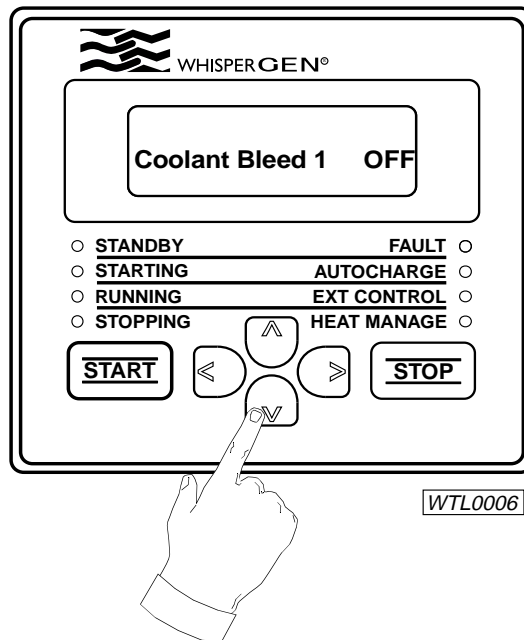

12. Allow the coolant to rest for one minute.
13. Repeat steps 8 to 12 until coolant bleeds out of the coolant-bleeding valve without air bubbles.
14. Close the coolant-bleeding valve securely.

-
15. Repeat steps 3 to 7 to begin editing the coolant pump setting, and then press √ to turn off the coolant pump.

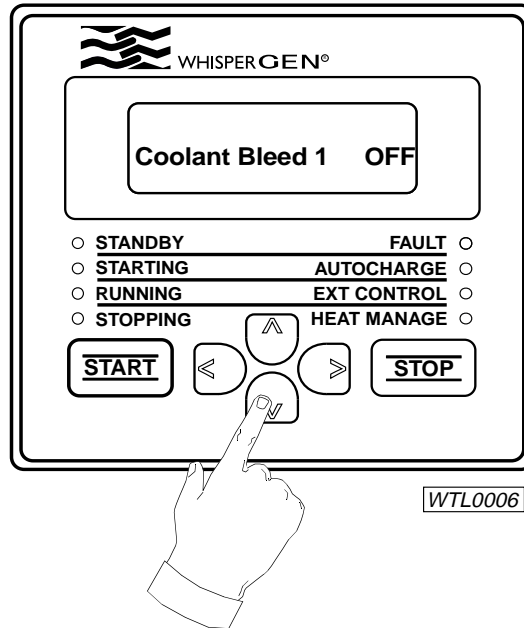

16. Optional: press < repeatedly to return to the default display. You can also let the default display re-appear automatically by allowing a few minutes of inactivity on the control panel.
17. Replace the enclosure lid.

The WhisperGen may now be started as required.

The information below applies to marine units only.

The seawater circuit may need to be bled if the seawater pump inlet has been lifted above seawater level. To bleed the seawater circuit, follow steps 1, 3, 4, 5, 6, 7, and 8 above but turn on **Coolant Bleed 2** instead of **Coolant Bleed 1** in the **Installation Menu**. The seawater pump – and the coolant pump – will be turned on to bleed both the seawater and coolant circuits for one hour after which the pumps will automatically stop. You can also stop the pumps at any time by pressing √.

Checking Battery Bank Connections

Power flows between the WhisperGen and battery bank via two power cables connected to the terminals of the battery bank. The WhisperGen also monitors the battery bank voltage, current, and temperature via electrical wires connected to the battery bank. If an electrical fault or warning occurs, these electrical connections may need to be checked – refer to the trouble shooting section. In general, the battery bank connections should be checked every three months.

To check the battery bank connections:

1. Access the battery bank managed by the WhisperGen, and ensure that the battery bank connections, as shown below, are intact and clean.

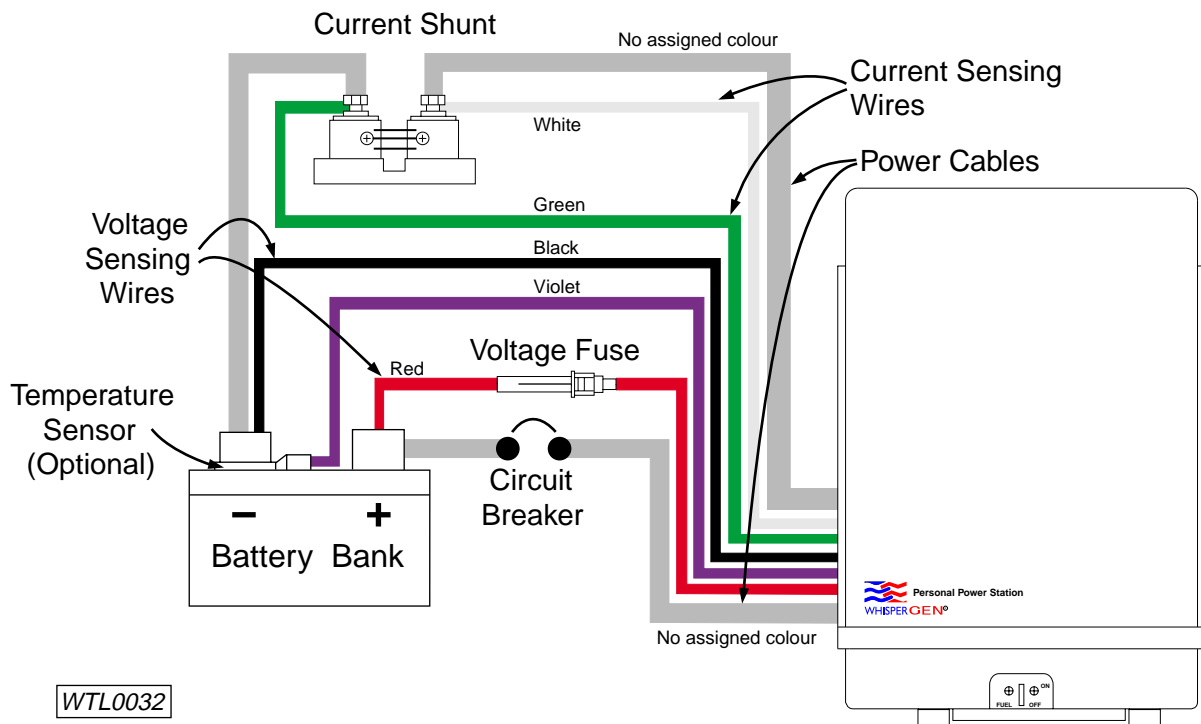

2. Check that the circuit breaker is closed.
3. Replace the voltage fuse if it has blown.
4. Check that the electrical insulation of the wires/cables is intact.
5. Remove the enclosure lid.



Do not touch the surfaces that are labelled as hot.

- Check that the electrical connections on the side of the electronics enclosure, as shown below, are intact. Before re-securing a wire/cable, first stop the WhisperGen and disconnect the WhisperGen from the battery bank by opening the circuit breaker.



If stopping the WhisperGen to re-secure a wire/cable, heed the warning given at the beginning of this section to prevent unintentional starts of the WhisperGen.

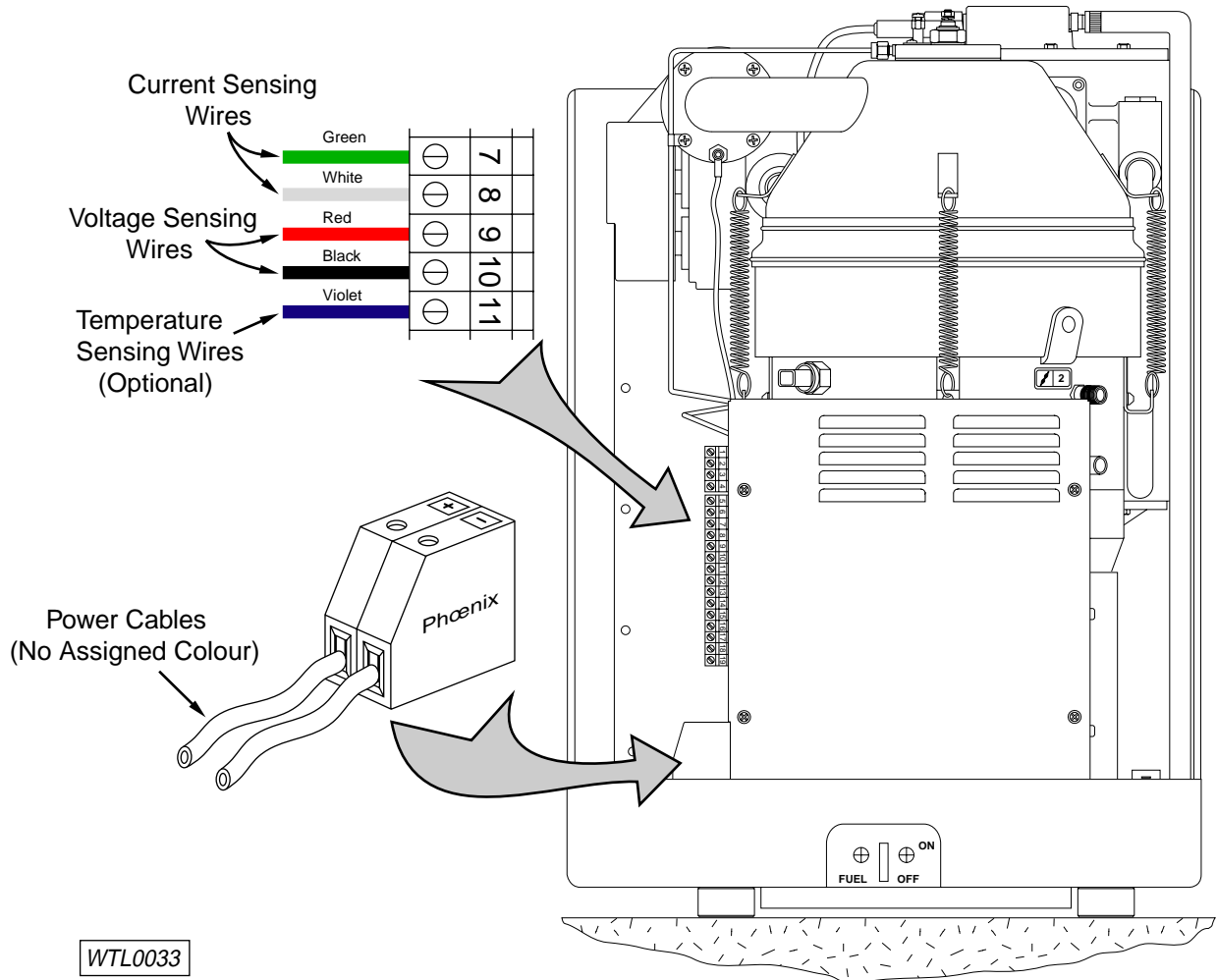

- Replace the enclosure lid. If you had disconnected the WhisperGen from the battery bank, reconnect it by closing the circuit breaker.

If an electrical fault persists or if the electrical insulation of the wires/cables is worn, contact your authorised WhisperGen service agent.

Replacing the Glow Plug

Should a “Glowplug cct fault” error message be displayed on the control panel, and the glow plug circuit fuse is intact, it may be necessary to replace the glow plug. In general, you should check the glow plug circuit fuse before deciding to replace the glow plug.

To replace the glow plug:

1. Stop the WhisperGen and wait until the **STANDBY** indicator on the control panel is lit.



To prevent unintentional starts of the WhisperGen, heed the warning given at the beginning of this section.

2. Remove the enclosure lid and wait for the engine to cool.



Do not touch the surfaces that are labelled as hot.

3. Remove the nut on top of the glow plug and detach the wire.

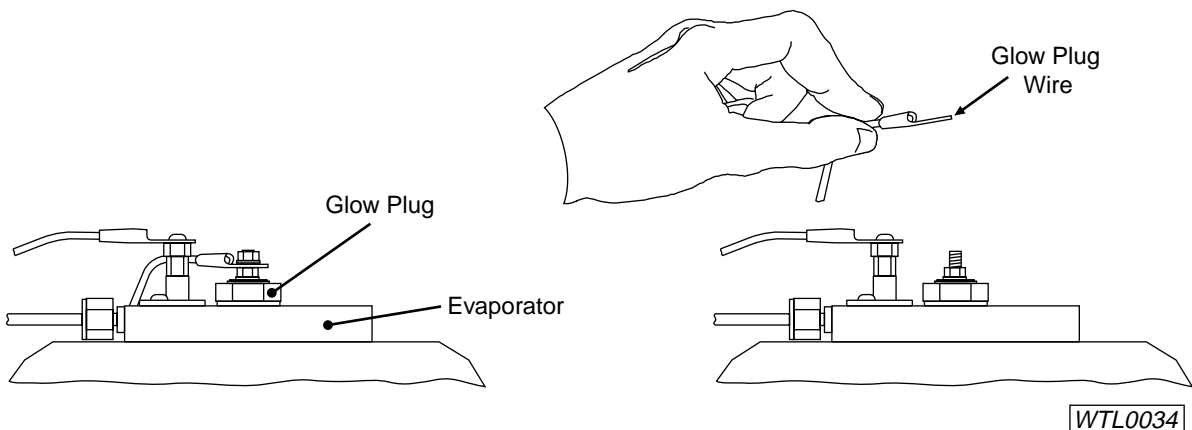

4. Unscrew the glow plug using a 22mm (spark-plug size) spanner.

5. Remove the glow plug.



The glow plug may be hot.

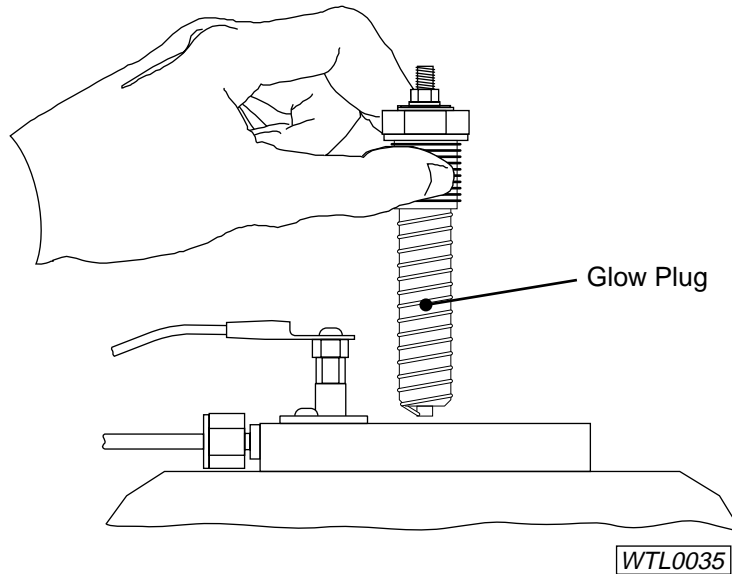

6. Insert a new glow plug with a washer into the evaporator and fasten the glow plug securely with a torque of 20 to 25Nm.



Do not touch the wire coil on the new glow plug, as this will shorten its life span.

7. Replace the wire terminal and washer on the threaded tip of the glow plug and fasten the nut securely.

8. Replace the enclosure lid.

The old glow plug can be returned to your authorised WhisperGen service agent for checking.



It is advisable to keep a spare glow plug with the WhisperGen at all times.



Glow plugs used on the WhisperGen should be obtained from authorised WhisperGen agents.

Replacing Fuses

Replacing the Battery Bank Voltage Fuse

The WhisperGen detects the voltage of the battery bank via two wires connected to the terminals of the battery bank as shown below. If the battery bank voltage displayed on the control panel is abnormal, it may be that the fuse in the circuit has blown.



Before replacing a fuse, find out the cause of the fault. Otherwise, damage to equipment may occur. If you are unsure of the cause of the fault, contact your authorised WhisperGen service agent for assistance.

To replace the battery bank voltage fuse:

1. Unscrew the fuse holder.

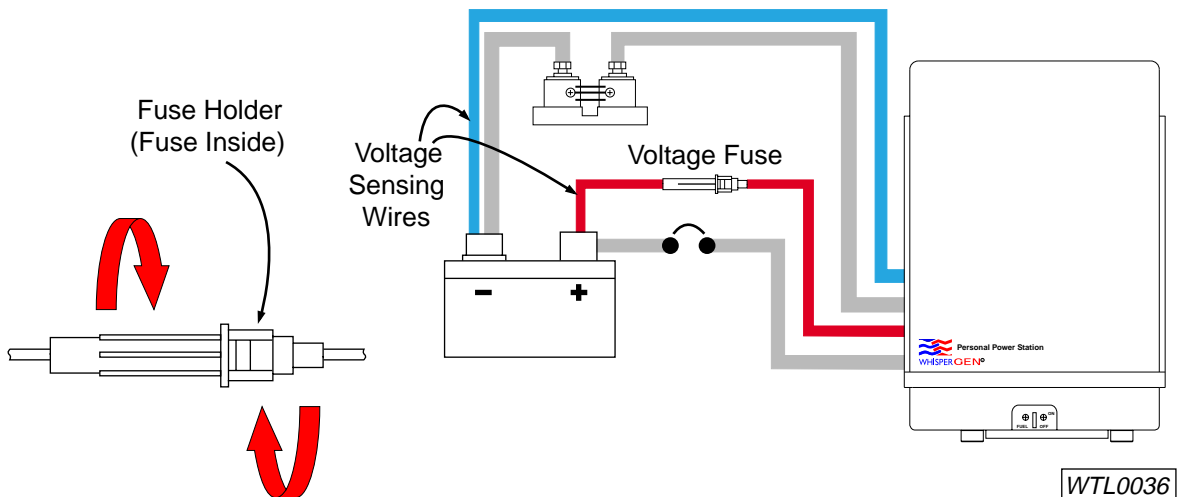

2. Replace the faulty fuse.



Ensure that the replacement fuse is of a similar type (Ø0.25 x 1.25 inch, or Ø6.35 x 31.75mm) and of the correct current rating (2.00A). It is advisable to keep spare fuses with the WhisperGen at all times.

3. Fasten the fuse holder.

WhisperGen fuses can be obtained from electrical hardware suppliers or your authorised WhisperGen service agent.

Replacing Other Fuses

The WhisperGen has fuses that protect against overloading of its electrical circuits. If a circuit is overloaded, the fuse will blow and the WhisperGen will shut down with the fault indicated on the control panel.



Before replacing a fuse, find out the cause of the fault. Otherwise, damage to equipment may occur. If you are unsure of the cause of the fault, contact your authorised WhisperGen service agent for assistance.

To replace a fuse (other than the battery bank voltage fuse):

1. Stop the WhisperGen and wait until the **STANDBY** indicator on the control panel is lit, then remove the enclosure lid.



To prevent unintentional starts of the WhisperGen, heed the warning given at the beginning of this section.



Do not touch the surfaces that are labelled as hot.

2. Disconnect the WhisperGen from the battery bank by opening the circuit breaker.
3. Release the four screws securing the cover of the electronics enclosure and remove the cover.

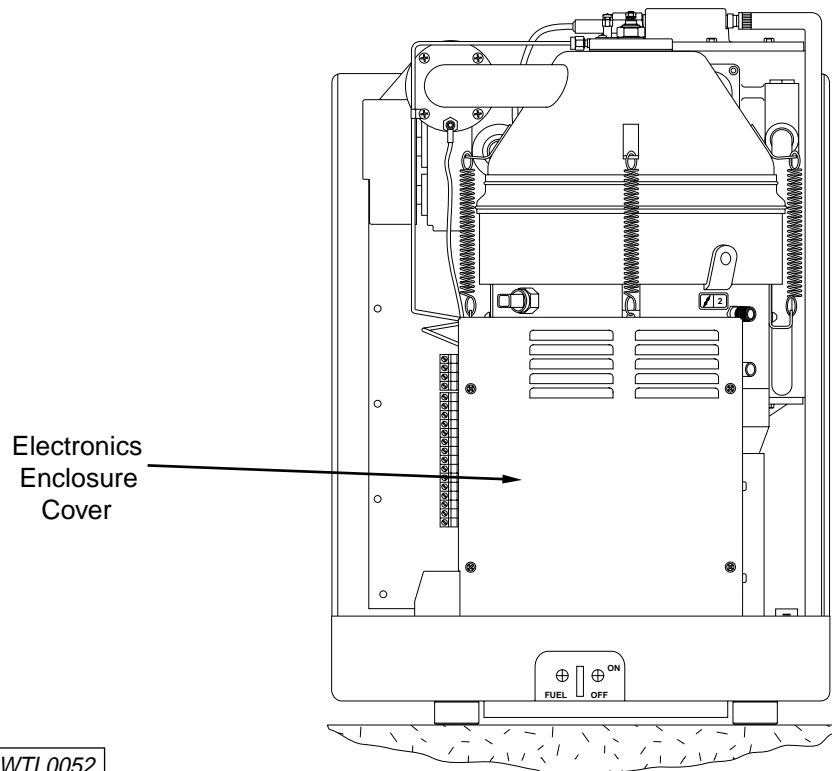

- Remove the appropriate fuse and check if it has blown. The fuses are located at the bottom of the electronics enclosure and are marked with their current ratings in Ampere. Error codes displayed on the control panel help identify which circuit and therefore which fuse may possibly have blown.

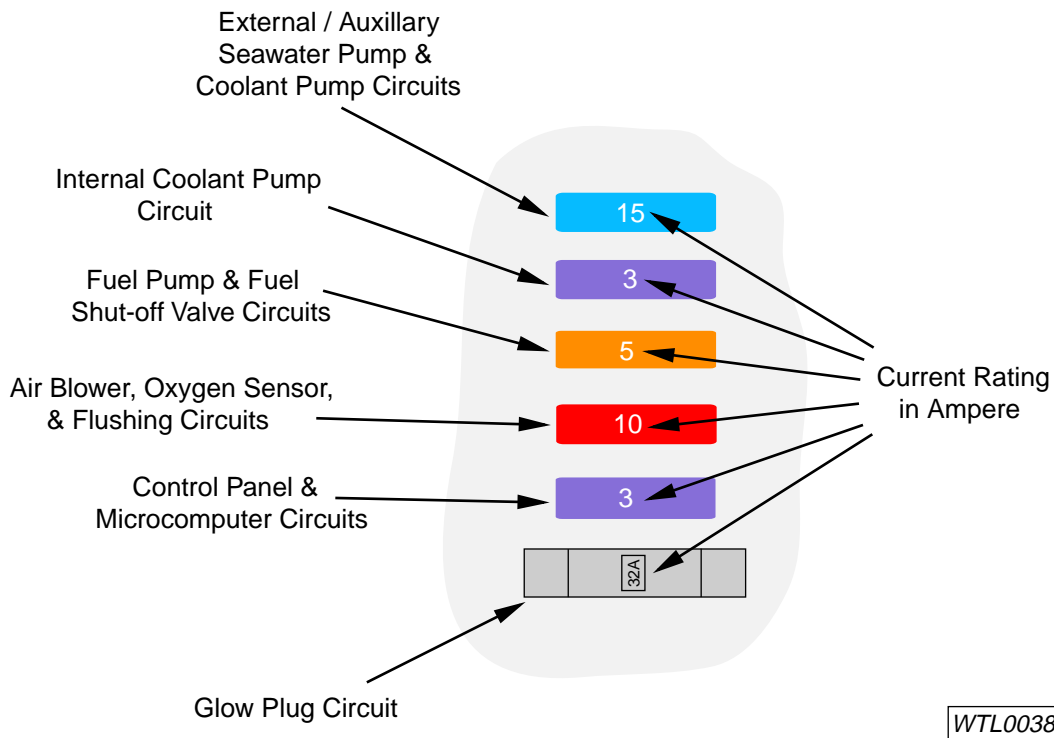

- Replace the faulty fuse.



Ensure that the replacement fuse is of a similar type and of the correct current rating.

- Replace the electronics enclosure cover and fasten the four screws.
- Replace the enclosure lid.
- Reconnect the WhisperGen to the battery bank by closing the circuit breaker.



It is advisable to keep spare fuses with the WhisperGen at all times.

WhisperGen fuses can be obtained from electrical hardware suppliers or your authorised WhisperGen service agent.

Replacing the FID

The condition and vertical position of the flame ionisation detector (FID) should be checked if error codes 58, 59, 60, 61, or 62 occur repetitively.

To check and/or replace the FID:

1. Stop the WhisperGen and wait until the **STANDBY** indicator on the control panel is lit.



To prevent unintentional starts of the WhisperGen, heed the warning given at the beginning of this section.

2. Remove the enclosure lid and wait for the engine to cool.



Do not touch the surfaces that are labelled as hot.

3. Undo the screw on top of the FID and detach the wire.



It is important not to twist the brass nut on the FID as this may damage the FID.

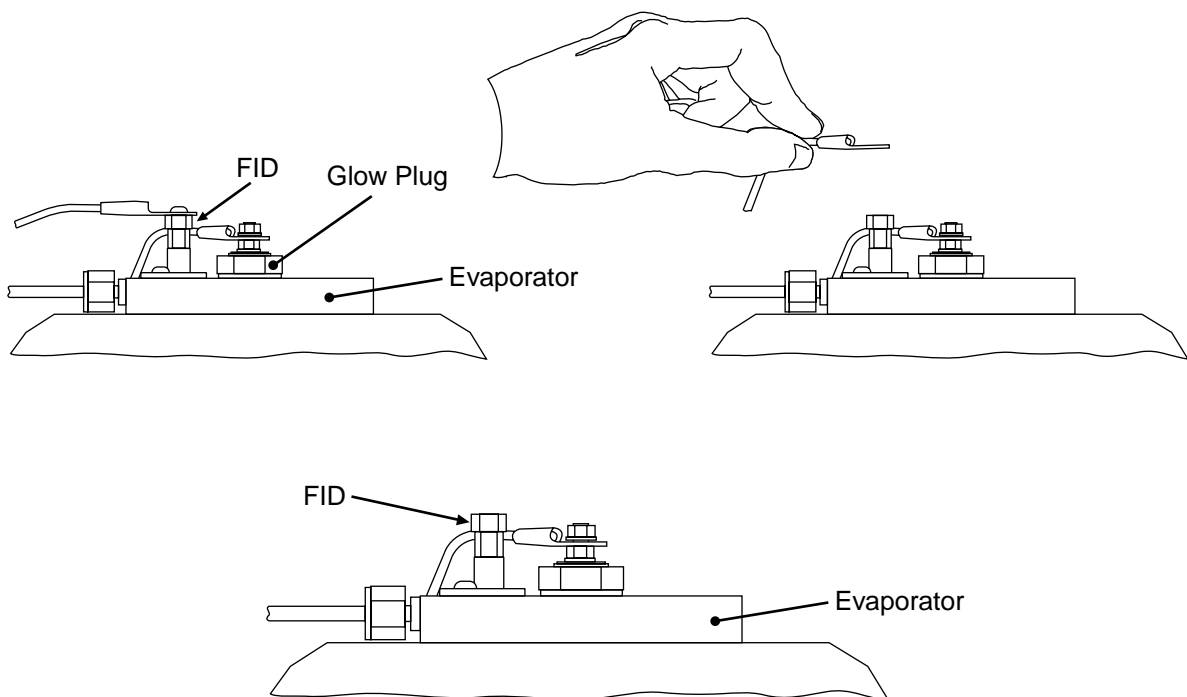

WTL0039

4. Undo the screw that secures the FID clip to the evaporator.
5. Lift the FID out of the evaporator, gripping the FID below the brass nut with a pair of pliers if necessary. Twist the FID from side to side while pulling it straight up.
6. Check the FID for cracks and that the electrode tip at the bottom of the FID is protruding by at least one millimetre. Also check that there is electrical continuity between the brass nut and

the electrode tip. If the FID is cracked, has less than one millimetre of the electrode protruding, or has electrical discontinuity, it should be replaced with a new one. Otherwise, the FID is re-usable.

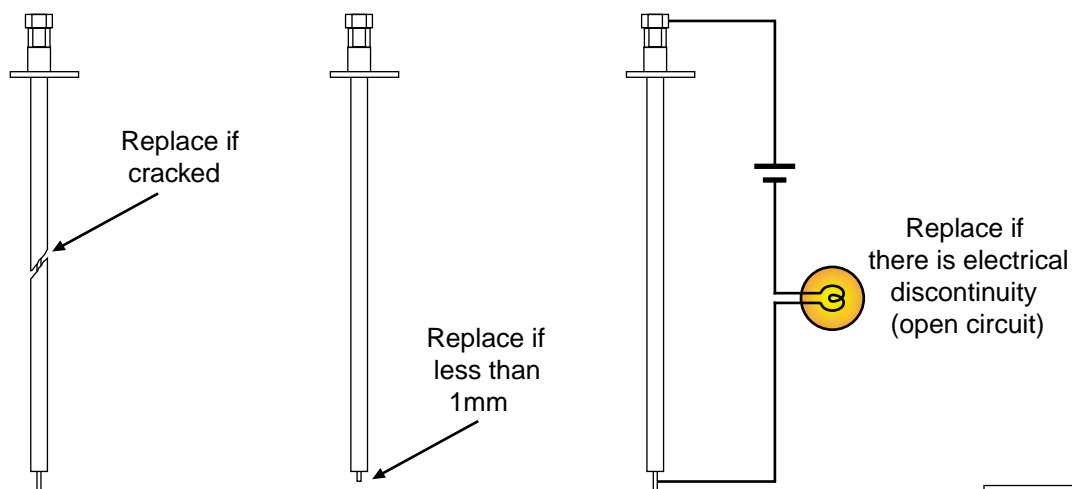

WTL0040

7. Insert a straight length of rigid wire vertically into the FID hole. The wire should go down 135 ± 10 mm.

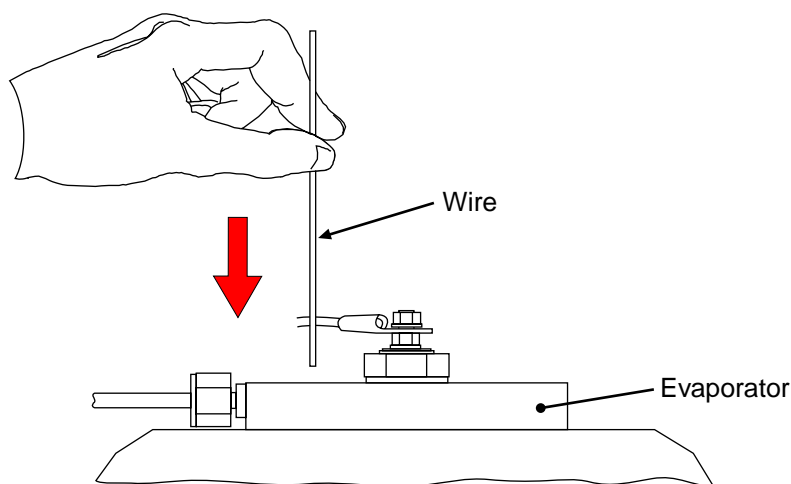

WTL0041

8. With the wire touching the base of the FID hole, mark on the wire the top level of the evaporator.

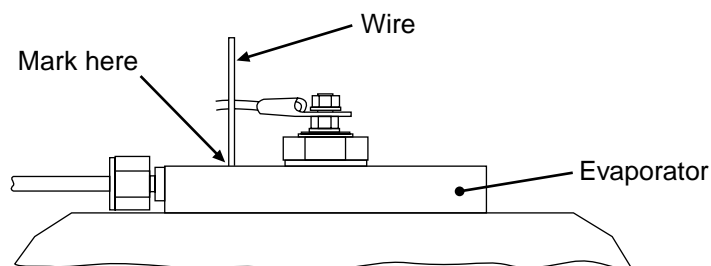

WTL0042

9. Lift the wire up by 6mm (no less than 5mm and no more than 8mm) and put a second mark on the wire at the top level of the evaporator.

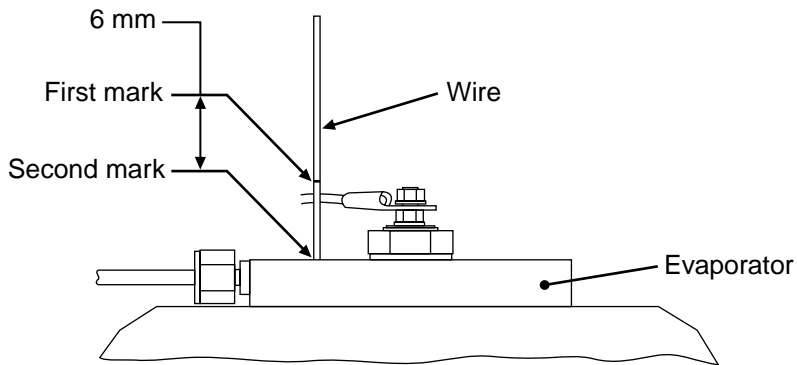

WTL0043

10. Remove the wire from the evaporator and move the FID clip so that the distance from the clip to the electrode tip is the same as the distance from the second mark on the wire to the bottom tip of the wire. To move the clip, wedge it open slightly with a screwdriver.

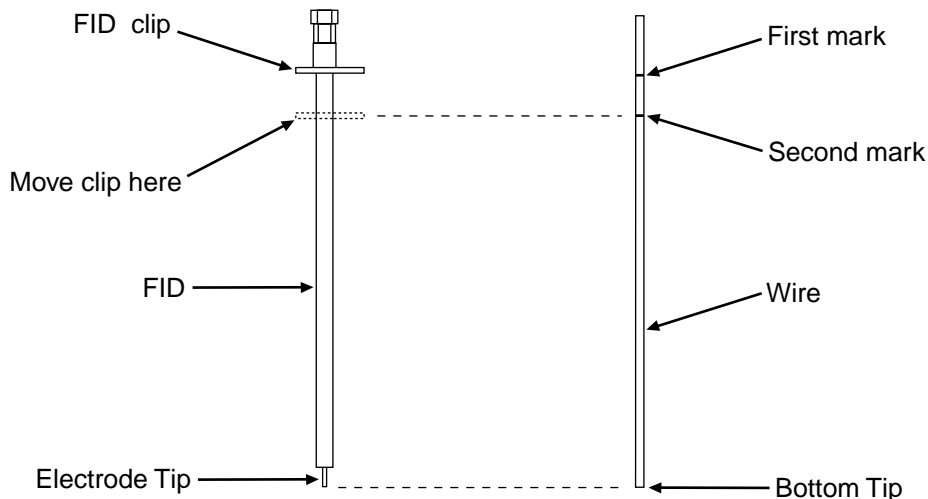

WTL0044

11. Without shifting the vertical position of the clip, insert the FID into the FID hole, gripping the FID below the brass nut with a pair of pliers if necessary. Twist the FID from side to side while pushing it straight down.



It is important not to twist the brass nut on the FID as this may damage the FID.

12. Fasten securely the FID clip to the evaporator, and the wire terminal to the FID.

13. Replace the enclosure lid.

The WhisperGen may now be started as required.



It is advisable to keep a spare FID with the WhisperGen at all times.

Replacing the Oxygen Sensor

The oxygen sensor should be replaced if error codes 10, 14, 56, 60, 61, 62, or 76 occur repetitively. In general, you should check the FID before deciding to replace the oxygen sensor.

To replace the oxygen sensor:

1. Stop the WhisperGen and wait until the **STANDBY** indicator on the control panel is lit.



To prevent unintentional starts of the WhisperGen, heed the warning given at the beginning of this section.

2. Remove the enclosure lid and wait for the engine to cool.



Do not touch the surfaces that are labelled as hot.

3. Detach the electrical connector of the oxygen sensor by squeezing the two side clips.

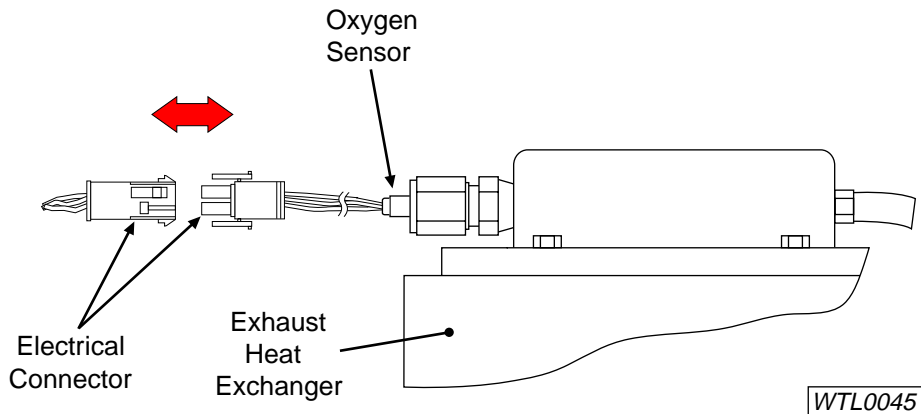

4. Undo the nut that holds the oxygen sensor in place.

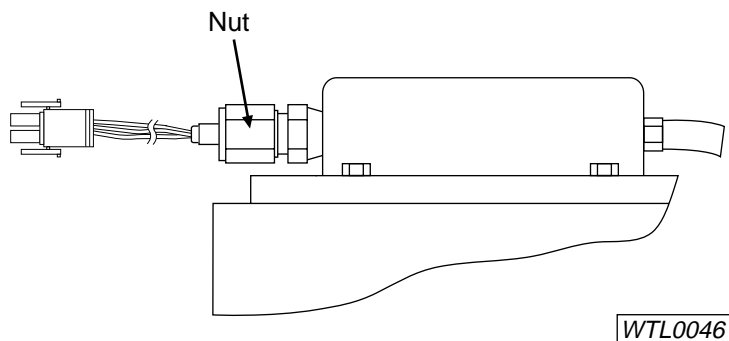

5. Remove the oxygen sensor.

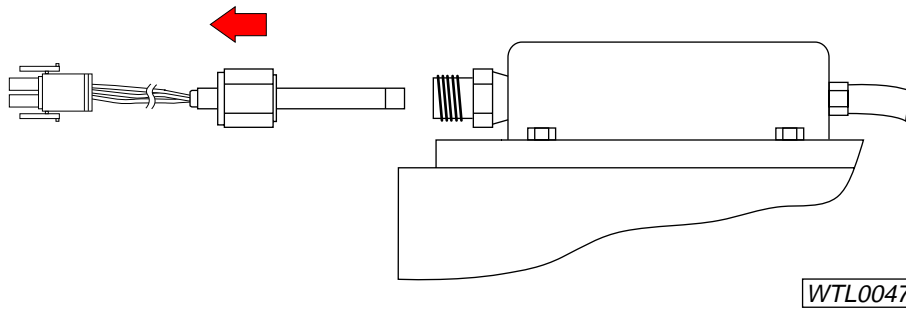

6. Insert a new oxygen sensor into the oxygen sensor hole. *Note: the ferrules should already be set in position on the oxygen sensor. The ferrules should be distanced 60mm from the sensing tip of the oxygen sensor.*



Do not touch the sensing tip of the oxygen sensor, as this will shorten its life span.

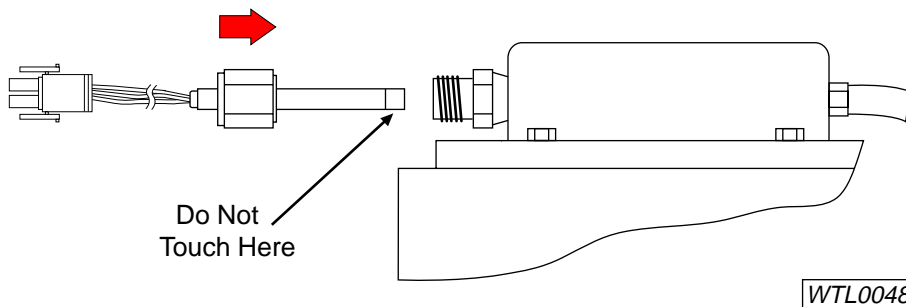

7. Finger tighten the nut that holds the oxygen sensor in place. Using a spanner tighten $1\frac{1}{4}$ turns only.
8. Re-fit the electrical connector.
9. Replace the enclosure lid.

The WhisperGen may now be started as required.



It is advisable to keep a spare oxygen sensor with the WhisperGen at all times.

Replacing the Evaporator

The evaporator should be replaced if error codes 10, 58, 59, 60, 61, or 62 occur repetitively. In general, you should check and/or replace the FID and oxygen sensor before deciding to replace the evaporator.

To replace the evaporator:

1. Remove the FID.
2. Remove the glow plug.
3. Turn off the WhisperGen fuel valve.

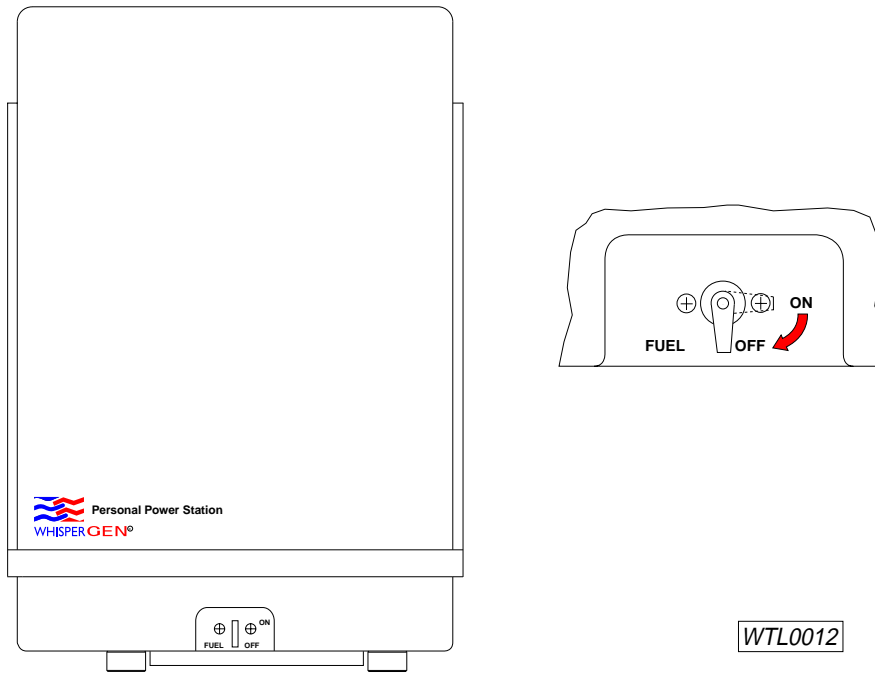

4. Unscrew the fuel line fitting on top of the burner.

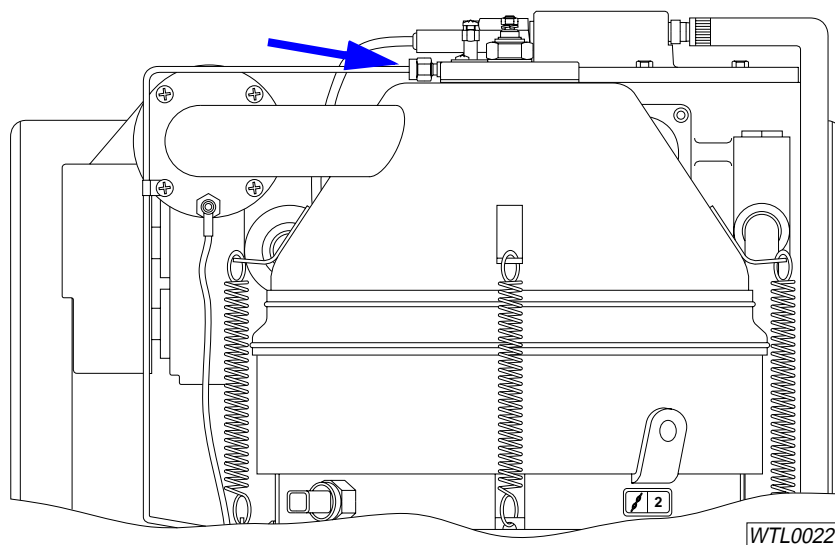

5. Undo the four screws on top of the evaporator.

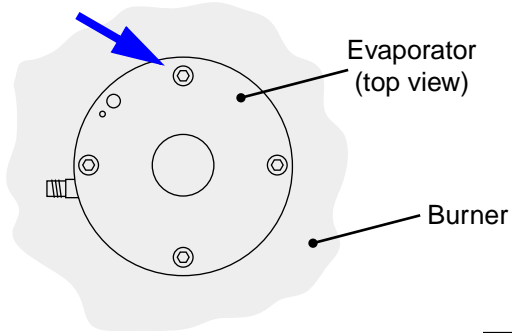

WTL0049

6. Lift the evaporator out of the burner.

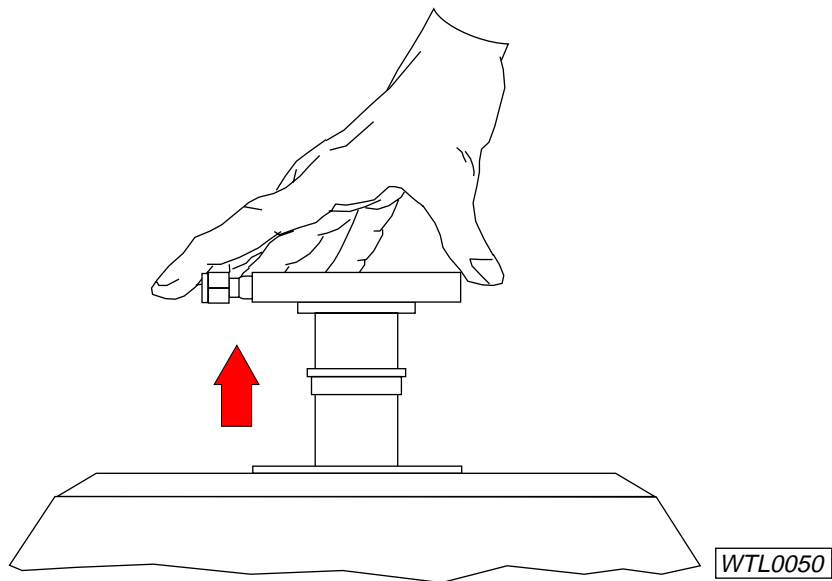

WTL0050

7. Place the evaporator gasket on the new evaporator, ensuring that all the holes line up.

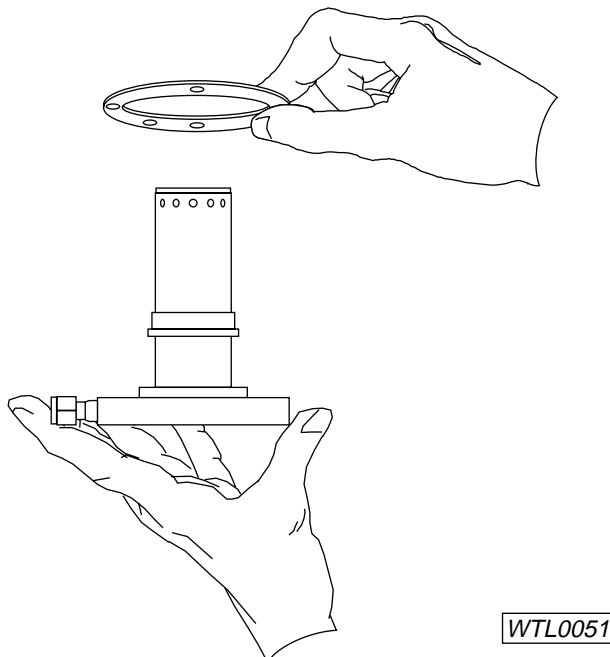

WTL0051

-
8. Insert the new evaporator with the gasket into the burner and secure the four screws.
 9. Check that the FID slides freely into the burner. If necessary, loosen the four evaporator screws and readjust the position of the evaporator before re-tightening them.
 10. Refit the glow plug.
 11. Reconnect the fuel line to the evaporator. Finger tighten the nut against the shoulder. Using a spanner tighten $\frac{3}{4}$ turn only.
 12. Ensure that there is no leakages.
 13. Refit the FID.
 14. Bleed the fuel line. Refer to section entitled - Bleeding the Fuel Line.
 15. Replace the enclosure lid.
 16. Turn on the WhisperGen fuel valve.

The WhisperGen may now be started as required. The old evaporator can be returned to your authorised WhisperGen service agent for servicing.



The evaporator should be serviced by an authorised WhisperGen service agent only. Do not attempt to do it yourself.



It is advisable to keep a spare evaporator with the WhisperGen at all times.

Flushing the Exhaust Heat Exchanger

The exhaust heat exchanger should be kept free from blockages to ensure optimum performance of the WhisperGen. In general you should flush the exhaust heat exchanger at least every 3 months.



If the exhaust heat exchanger becomes blocked the performance of the WhisperGen will decrease.

To flush the exhaust heat exchanger:

1. Stop the WhisperGen and wait until the **STANDBY** indicator on the control panel is lit. Refer the section entitled Stopping the WhisperGen.
2. To access the Main Menu on the control panel - follow the first two steps of the procedure outlined in the section entitled Stopping the WhisperGen - Setting the maximum run time.
3. Press ∇ to scroll down to Installation Menu.

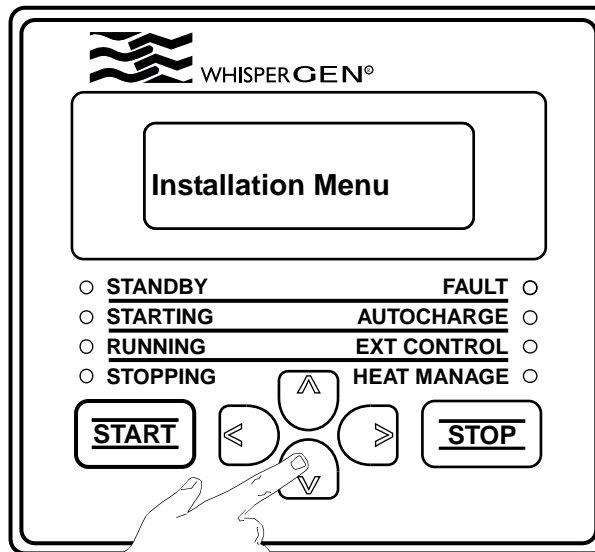

WTL0006

4. Press $>$ to display the first item on the installation menu, heat exchanger nozzle bleed.

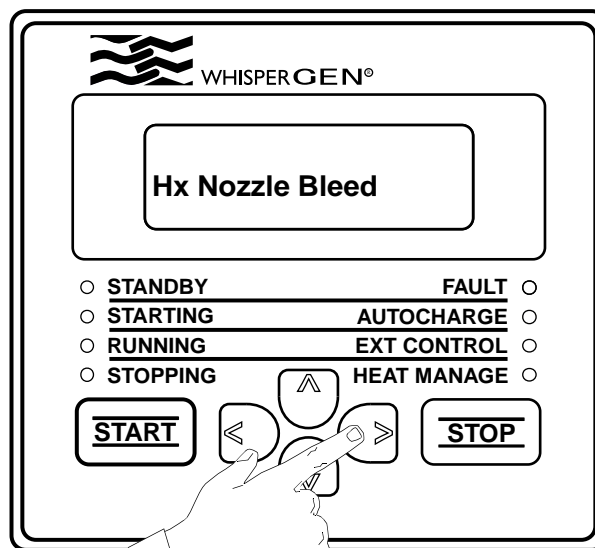

WTL0006

-
5. Press ∇ to scroll down to heat exchanger nozzle bleed.

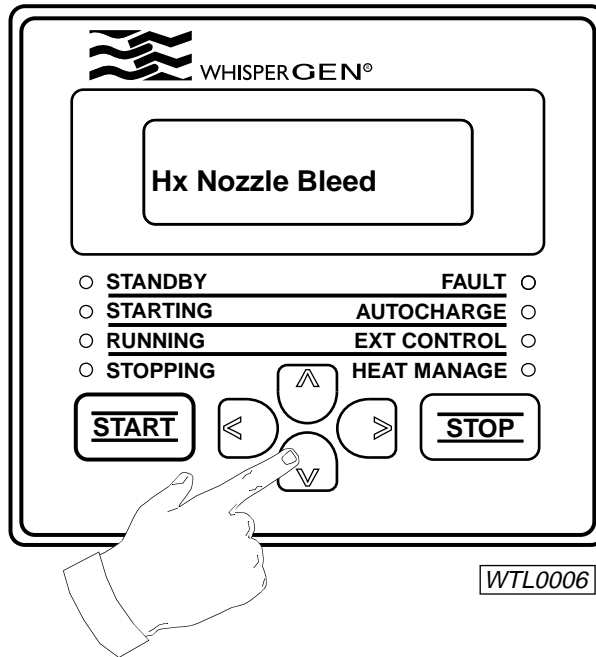

6. Press $>$ to begin editing the heat exchanger bleed setting.
7. Press \wedge to select **ON**, then press $<$ to begin flushing the exhaust heat exchanger. Flushing will continue for 10 seconds.

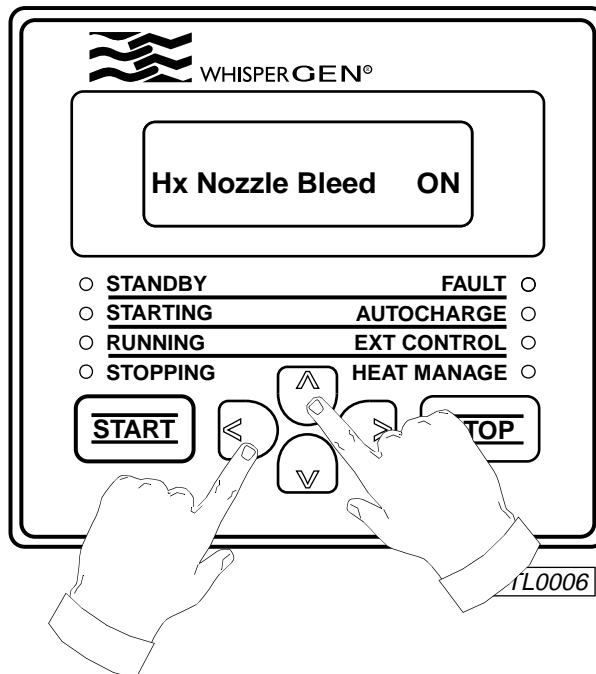

8. Once the heat exchanger bleed shows **OFF** repeat steps 6 and 7 two more times.

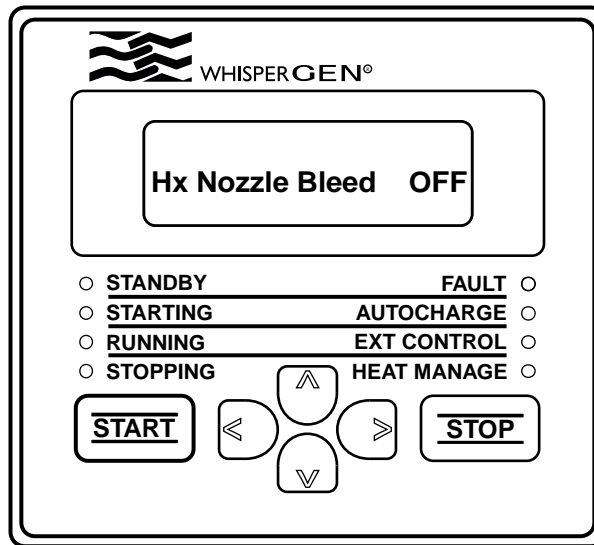

WTL0006

This flushes the system a total of 3 times.

9. Optional: press < repeatedly to return to the default display. You can also let the default display re-appear automatically by allowing a few minutes of inactivity on the control panel.

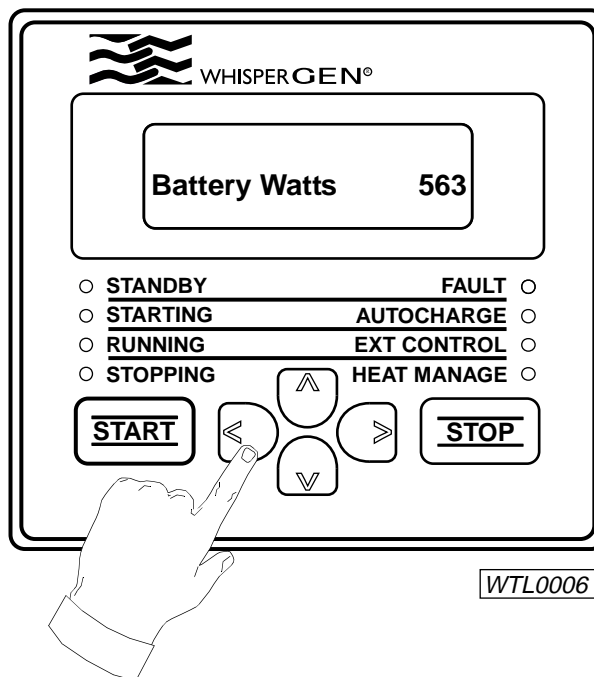

WTL0006

The WhisperGen may now be started as required.

Trouble Shooting

The WhisperGen automatically alerts the user to most errors. Errors may be faults or warnings. If a fault occurs, the WhisperGen will automatically clear the fault and attempt to restart. By default, the WhisperGen will attempt to restart once. If you wish to change this setting, contact your authorised WhisperGen agent.

This section outlines faults and warnings that you may encounter and need to correct. After a fault is physically corrected, the error message displayed on the control panel needs to be cleared before normal operation may be resumed. Although a warning can be cleared without the physical cause being first removed, it is recommended that the cause be determined and removed at the earliest opportunity. Refer to section entitled Clearing Faults and warnings for more information.

If you need assistance, please contact your authorised WhisperGen service agent.



You should read and understand all safety precautions before operating or maintaining your WhisperGen.

Correcting Faults



When remedying WhisperGen faults, please follow the recommendations in this manual otherwise, you may injure yourself and the warranty will be void. If the recommended action does not remedy the fault, contact your authorised WhisperGen service agent.

Code	Error Message	Likely Cause and Recommended Action
2	Exh overtemp	Likely cause: Low gas pressure and/or burner seal has failed. Recommended Action: Attempt to restart, contact an authorised WhisperGen service agent if problem reoccurs.
4	Block overtemp	Likely cause: Insufficient cooling of the engine block. Recommended Action: Check coolant level. Check for obstructions in coolant and seawater circuits. Allow engine to cool and restart.
6	Heatsink overtemp	Likely cause: Excessive power loss in electronic assembly, or poor air-cooling within electronics enclosure. Recommended Action: Ensure ambient temperature is below 40°C. Ensure airflow from the base of the enclosure through to the electronics heat sink is not blocked. Ensure the enclosure lid is fitted and well sealed. Restart.
7	Electronics too hot	See 6.
8	Waterflow stopped	This error only appears when the flow switch monitoring software is enabled.

Code	Error Message	Likely Cause and Recommended Action
12	Air supply fail	Likely cause: Air blower tachometer signal out of range, obstruction of impeller, or electrical fault. Recommended Action: Check connections and presence of any obstructions. Restart.
14	O2 sensor failure	Likely cause: Absence of normal signal from oxygen sensor, or faulty oxygen sensor. Recommended Action: Check connections, replace oxygen sensor if fault continues. Restart.
16	Fuse/Daisy Ch fail	Likely cause: Electrical or thermal fuse blown, or break in burner safety circuit. Recommended Action: Check for high water temperature, high internal temperature. Check for blown fuses and restart. If restarting fails, check coolant level and allow engine to cool before restarting.
18	Low batt volts	Likely cause: Insufficient voltage to start the WhisperGen. Recommended Action: Check condition of battery bank and terminals. If restarting fails, check the batteries. Replace faulty batteries and restart.
19	High batt volts	Likely cause: Battery higher than 18 or 36 volts. Recommended Action: Check condition of battery bank and terminals.
20	Bus not charged	Likely cause: Fault in electronics assembly or in battery bank voltage sensing wires. Recommended Action: Attempt to restart, contact an authorised WhisperGen service agent if problem reoccurs.
24	Isolator open	Likely cause: Abnormal electrical condition. Recommended Action: Attempt to restart, contact an authorised WhisperGen service agent if problem reoccurs.
28	Stuck flowswitch	This error only appears when the flow switch monitoring software is enabled.
30	Low batt volts	See 18.
32	Bus not charged	See 20.
34	Isolator stuck on	Likely cause: Abnormal electrical condition. Recommended Action: Attempt to restart, contact an authorised WhisperGen service agent if problem reoccurs.
35	Low batt volts	See 18.

Code	Error Message	Likely Cause and Recommended Action
36	Glowplug cct fault	Likely cause: Glow plug faulty and/or glow plug fuse blown. Recommended Action: Check glow plug fuse. If the fuse is intact, replace the glow plug and restart. If the fuse is blown, replace both the glow plug and fuse.
38	Bus not charged	See 20.
40	Isolator open	Likely cause: Abnormal electrical condition. Recommended Action: Attempt to restart, contact an authorised WhisperGen service agent if problem reoccurs.
44	Fuel sense fail	Likely cause: Abnormal electrical condition. Recommended Action: Attempt to restart, contact an authorised WhisperGen service agent if problem reoccurs.
46	Flame sense fail	Likely cause: Abnormal electrical condition. Recommended Action: Attempt to restart, contact an authorised WhisperGen service agent if problem reoccurs.
48	Drive bridge fail	Likely cause: Abnormal electrical condition. Recommended Action: Attempt to restart, contact an authorised WhisperGen service agent if problem reoccurs.
52	Fuel supply fail	Likely cause: Abnormal electrical condition. Recommended Action: Attempt to restart, contact an authorised WhisperGen service agent if problem reoccurs.
54	Flame sense fail	See 46.
56	O2 sensor fail	Likely cause: Oxygen sensor signal not within expected range. Recommended Action: Check connectors and restart. Replace oxygen sensor if fault continues.
58	Ignition failure	Likely cause: No proper flame signals within two minutes after ignition. Recommended Action: Check fuel level, fuel valve, and fuel filter. Restart. Replace FID if fault continues. Restart. Replace evaporator if fault continues.
59, 60, 61, 62	Flame failure	Likely cause: Loss of flame after ignition. Recommended Action: Check fuel level, fuel valve, and fuel filter. Restart. Replace FID if fault continues. Restart. Replace oxygen sensor if fault continues. Restart. Replace evaporator if fault continues.

Code	Error Message	Likely Cause and Recommended Action
64	Heatup failure	Likely cause: Failure to reach cranking temperature within eight minutes. Thermocouple failure or poor flame strength. Recommended Action: Check fuel level, fuel valve, and fuel filter. Check exhaust for blockage. Attempt to restart, contact an authorised WhisperGen service agent if problem reoccurs.
66	Crank failure	Likely cause: Unsuccessful crank attempt, probably due to an electrical fault. Recommended Action: Attempt to restart, contact an authorised WhisperGen service agent if problem reoccurs.
68	Engine sluggish	Likely cause: Low power output after cranking, possibly due to low gas pressure. Recommended Action: Attempt to restart, contact an authorised WhisperGen service agent if problem reoccurs.
72	Drive bridge fail	Likely cause: Abnormal electrical condition. Recommended Action: Attempt Restart, contact an authorised WhisperGen service agent if problem reoccurs.
74	Low engine power	Likely cause: Low power output, possibly due to low gas pressure. Low fuel flow. Recommended Action: Check fuel level, fuel valve, and fuel filter. Check exhaust for blockage. Flush heat exchanger. Restart, if problem reoccurs contact an authorised WhisperGen service agent .
76	O2 sensor OOL	Likely cause: Oxygen sensor reading out-of-limits, possibly resulting in poor combustion. Recommended Action: Check connector and restart. Replace oxygen sensor if fault continues.
80	Clamp failed on	Likely cause: Abnormal electrical condition. Recommended Action: Contact authorised WhisperGen service agent.
82	Excess volt drop	Likely cause: Too high electrical resistance between the WhisperGen and battery bank. Recommended Action: Check battery bank connections and battery bank voltage sensing wires. Restart.

Code	Error Message	Likely Cause and Recommended Action
83	Battery overtemp	Likely cause: Battery bank temperature too high for safe charging. Recommended Action: Check battery bank connections and ventilate battery bank compartment. Restart.
84	Clamp failed off	Likely cause: Abnormal electrical condition, possibly resulting in raised battery voltage. Recommended Action: Attempt to restart, contact an authorised WhisperGen service agent if problem reoccurs.
85	High batt volts	Likely cause: Battery bank voltage above normal charging limits. Recommended Action: Check settings of any parallel charger connected to the battery bank. Restart.
90	Clamp control flt	Likely cause: WhisperGen unable to maintain correct battery charging voltage. Recommended Action: Attempt to restart, contact an authorised WhisperGen service agent if problem reoccurs.
92	ParChg V too high	Likely cause: WhisperGen operating voltage has gone too high, in an effort to avoid conflict with a parallel charger. Recommended Action: Check voltage settings of other chargers connected to the battery bank. Restart.

Correcting Warnings

Although a warning can be cleared without the physical cause being first removed, it is recommended that the cause be determined and removed at the earliest opportunity. Warnings are indicated by a flashing **FAULT** indicator. No error message is displayed.



When remedying WhisperGen warnings, please follow the recommendations in this manual otherwise, you may injure yourself and the warranty will be void. If the recommended action does not remedy the warning, contact your authorised WhisperGen service agent.

Code	Likely Cause and Recommended Action
102	Likely cause: Exhaust gas hotter than normal, possibly due to low engine gas pressure. Recommended Action: Attempt to restart, contact an authorised WhisperGen service agent if problem reoccurs.

104	<p>Likely cause: Engine coolant hotter than normal.</p> <p>Recommended Action: Check coolant level. Check coolant and seawater circuits for obstructions. Check pumps for operation.</p>
107	<p>Likely cause: Temperature in electronics enclosure abnormally high.</p> <p>Recommended Action: Ensure ambient temperature is below 40°C. Ensure airflow from the base of the enclosure through to the electronics heat sink is not blocked. Ensure the enclosure lid is fitted and well sealed</p>
126	<p>Likely cause: Controller is reset while engine is running or engine is hot. This could be the result of a bad contact between the WhisperGen and the control panel.</p> <p>Recommended Action: New cable.</p>
135	<p>Likely cause: Low battery bank voltage.</p> <p>Recommended Action: Check battery bank connections and battery bank voltage sensing wires. Set a higher value for Max Run Hours and/or turn Auto-charge option ON.</p>
182	<p>Likely cause: Excessive voltage drop in cabling to battery bank.</p> <p>Recommended Action: Check battery bank connections and cables.</p>
183	<p>Likely cause: Battery bank temperature is high.</p> <p>Recommended Action: Check battery bank connections and ventilate battery bank compartment.</p>
190	<p>Likely cause: Battery bank voltage is unstable during charging.</p> <p>Recommended Action: Check battery bank connections and cables.</p>
195	<p>Likely cause: Battery bank is discharged below a preset level.</p> <p>Recommended Action: Start the WhisperGen if it is not operating. Reduce electrical load on the battery bank. Set a higher value for Max Run Hours and/or turn Auto-charge option ON.</p>

Resetting the WhisperGen

Resetting the control Panel

Due to unusual circumstances, the control panel may sometimes display an incoherent message. If this happens, the control panel should be reset.



When performing trouble shooting tasks on the WhisperGen, refer to the applicable section(s) when removing or replacing parts.

To reset the control panel:

1. Hold down < for at least six seconds. A beep will be heard and the control panel will return to the default display, indicating normal operation.

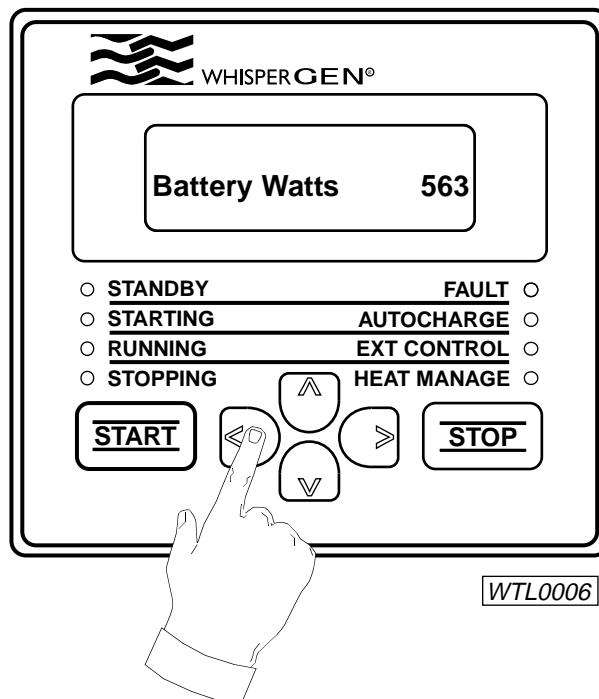

Resetting the Electronics Hardware

In some cases, extreme electrostatic interference may cause the WhisperGen to become unresponsive to key presses on the control panel. If this happens, the WhisperGen electronics hardware should be reset as soon as possible to ensure that the battery bank is kept charged.

To reset the WhisperGen electronics hardware:

1. Remove the enclosure lid.



Do not touch the surfaces that are labelled “Hot Surface”.

2. Remove the four screws in front of the electronics enclosure. Then remove the electronics enclosure cover.

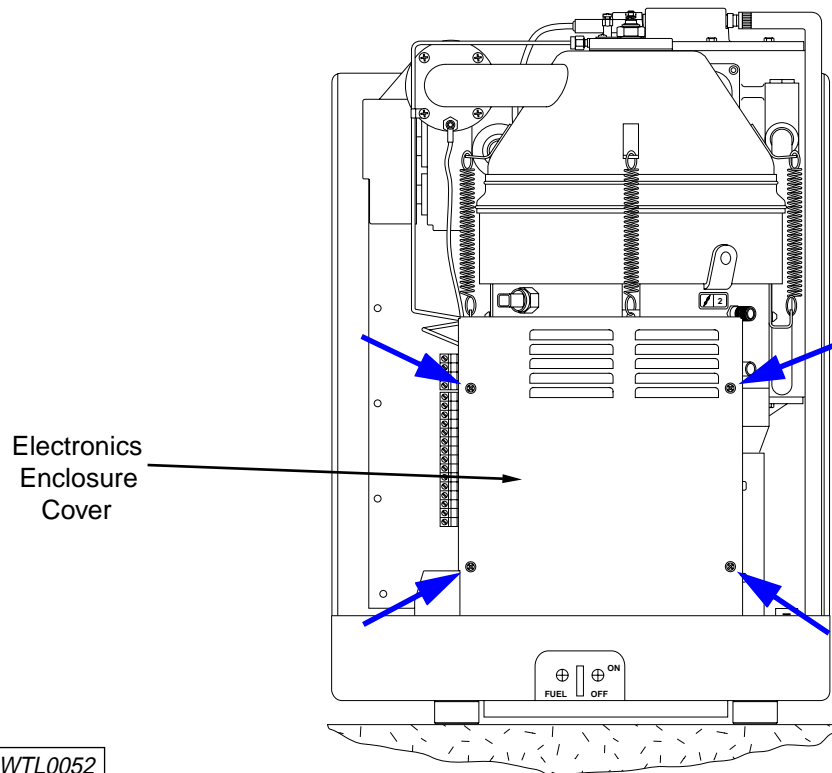

3. Unplug and then re-plug in the second fuse from the bottom - the fuse that has a current rating of 3A.

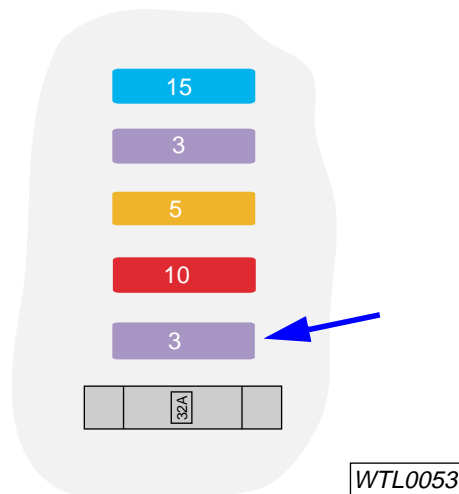

4. Check that the WhisperGen is responsive to key presses on the control panel. If the control panel display was completely blank, it may be that the fuse was blown. In such a case, check the fuse and if it has blown, replace it with a new one.



Ensure that the replacement fuse is of a similar type and of the correct current rating.

5. Replace the electronics enclosure cover and fasten the four screws.
6. Replace the enclosure lid.

Service Details

Authorised WhisperGen service agents who commission and/or service the WhisperGen should fill in this section.

The duplicate copy of the commissioning details should be detached and returned to your authorised service agent within 14 days of the commissioning date.

Commissioning

Engine Serial No.	Software Version	Commission Date
Commission Date	Customer's Address	
Heat Manage	Temp Setpoint	Auto-charge
Ext. Control	Ext Cont Mode	Max Run Hours
Battery Capacity	Max Batt Disch	Tail Current
Absorption Voltage	Float Voltage	Time Above 14V
SelfDisch/Mth	Hour Meter	# Of Starts
Agent's Stamp	Other Remarks	



Duplicate

Important: Transcribe details from the last page to this page. Then detach this sheet and return it to your authorised service agent within 14 days of the commissioning date.

Engine Serial No.	Software Version	Commission Date
Commission Date	Customer's Address	
Heat Manage	Temp Setpoint	Auto-charge
Ext. Control	Ext Cont Mode	Max Run Hours
Battery Capacity	Max Batt Disch	Tail Current
Absorption Voltage	Float Voltage	Time Above 14V
SelfDisch/Mth	Hour Meter	# Of Starts
Agent's Stamp	Other Remarks	

Servicing

Date / Hours	Description of Work Done	Agent's Stamp
DD MM YY / /		
Hour Meter Reading		
DD MM YY / /		
Hour Meter Reading		
DD MM YY / /		
Hour Meter Reading		
DD MM YY / /		
Hour Meter Reading		

Date / Hours	Description of Work Done	Agent's Stamp
DD MM YY / /		
Hour Meter Reading		
DD MM YY / /		
Hour Meter Reading		
DD MM YY / /		
Hour Meter Reading		
DD MM YY / /		
Hour Meter Reading		

EC Conformity

Manufacturer: Whisper Tech Ltd.,
224 Armagh Street
P.O. Box 13-705
Christchurch
New Zealand

Declares herewith that the WhisperGen PPS16 units:

Comply with the relevant requirements of the following EC directives:

98/37/EC	Machinery directive
89/336/EC, 92/31/EC, 98/13/EC	EMC directive

Comply with the relevant requirements of the following national standards and specifications:

Harmonised standards	
EN292-1 1991	Safety of machinery – basic concepts, general principles for design – basic terminology, methodology.
EN292-2 A2 1997	Basic concepts, general principles for design – technical principles and specifications.
EN294 A2 1993	Safety of machinery – safety distances to prevent danger zones being reached by upper limbs.
EN563 A1 1995	Safety of machinery – temperatures of touchable surfaces – ergonomics data to establish temperature limit values for hot surfaces.
EN1050 1996	Safety of machinery – principles for risk assessment.
EN50082-1 1997	Electromagnetic compatibility – generic immunity standard. Part 1. Residential, commercial and light industry.

Non-Harmonised standards	
BS799-2 1991	Specification for vaporising oil burners.
BS5500 1997	Unfired fusion welded pressure vessels.
ISO8528-10 1999	Reciprocating internal combustion engine driven alternating current generating set – Part 10: measurement of airborne noise.
IEC 61000-4-2 1998	EMC Part 4: testing and measurement techniques. Section 2: electrostatic discharge test – basic EMC publication.
IEC 61000-4-3 1995	EMC Part 4: testing and measurement techniques. Section 3: radiated, radio frequency, electromagnetic field immunity test.
IEC 61000-4-4 1995	EMC Part 4: testing and measurement techniques. Section 4: electrical fast transient burst immunity test – basic EMC publication.
IEC 61000-4-5 1995	EMC Part 4: testing and measurement techniques. Section 5: surge immunity test.
IEC 61000-4-6 1996	EMC Part 4: testing and measurement techniques. Section 6: immunity to conducted disturbances, induced by radio frequency fields.
IEC 61000-4-11 1994	EMC Part 4: testing and measurement techniques. Section 11: voltage dips, short interruptions and voltage variations immunity test.
ENV 50204 1996	Radiated electromagnetic field from digital radio telephones – immunity test.
CISPR 22 1997	Information technology equipment – radio disturbance characteristics – limits and methods of measurement.

This declaration issued by: Bill Highet
General Manager
Whisper Tech Ltd.

Date of issue: February, 2002

Place of issue: Christchurch, New Zealand.

Index

- Absorption-charging 27
- Air blower 8, 9
- Application 3, 4, 5
- Auto-charging 28

- Backlighting of LCD 36
- Battery bank 1, 27, 60, 64
- Battery bank voltage fuse 60, 64
- Bleeding coolant circuit 56
- Bleeding fuel line 50
- Bleeding seawater circuit 56
- Bulk-charging 27, 29
- Burner 2, 8, 9, 51

- CE conformity 90
- Charging battery bank 27
- Charging stages 27
- Checking battery bank connections 60
- Checking coolant level 55
- Checking fuel level 49
- Checking in general 48
- Circuit breaker 3, 4, 5
- Clamp 39
- Cleaning fuel filter 53
- Clearing faults and warnings 32
- Codes for faults and warnings 78
- Commissioning details 86
- Control panel 3, 4, 5, 8, 9
- Coolant level checking 55
- Coolant pump 3, 4, 5, 56
- Coolant temperature 30
- Correcting faults 78
- Correcting warnings 82
- Current shunt 3, 4, 5, 60

- Displaying parameter settings 41

- Earthing strap 8, 9
- EC conformity 90
- Editing parameter settings 43
- Electronics enclosure 8, 9, 64, 82
- Emergency stopping 21
- Enclosure 8, 9
- Error codes 78

- Evaporator 62, 72
- Exhaust heat exchanger 8, 9
- External control 25

- Fault 32, 78
- Fault clearing 78
- Fault codes 78
- Fault correcting 78
- Flame ionisation detector(FID) 8, 9, 67
- Float-charging 27
- Flushing the Exhaust Heat Exchanger 75
- Fuel filter cleaning 53
- Fuel level checking 49
- Fuel line 8, 9, 50
- Fuel pump 3, 4, 5, 50, 53
- Fuel type 6
- Fuel valve 8, 9, 18, 19, 21, 50
- Function of WhisperGen 1
- Fuse 60, 64, 85

- Gas pressure 6
- General checking 48
- Glow plug 8, 9, 62

- Hazards 11
- Heat management 30

- Information structure 17
- Installing WhisperGen 16

- Keys on control panel 10

- LCD contrast adjustment 35
- LCD backlight adjustment 36

- Maintenance 45
- Maintenance schedule 45
- Manual stopping 20

- Maximum running time 22
- Meaning of parameters 37

- Nitrogen gas 6

Operating options 16
Operating time 22
Operation 16
Oxygen sensor 8, 9, 70

Parameters 37
Parameter settings 41, 43
Pump 3, 4, 5, 50, 53, 56

Quick reference 16

Remote controlling 25
Removing enclosure lid 47
Replacing evaporator 72
Replacing FID 67
Replacing fuses 64
Replacing glow plug 62
Replacing oxygen sensor 70
Resetting control panel 81
Resetting electronics hardware 81

Safety precautions 11
Schedule for maintenance 45, 46
Seawater pump 3, 5, 56
Specifications 6, 7
Starting WhisperGen 18, 19
Stirling-cycle engine 2
Stopping WhisperGen 20
Summary of options 16
Summary of parts 8, 9
System parameters 37

Temperature of coolant 30
Troubleshooting 78

Warning 32, 82
Warning clearing 32
Warning codes 82
Warning correcting 82
Wobble yoke mechanism 2
Working principle 1